

THAILAND WATER-SEAL PRIVY SLAB

The Thailand Water-Seal Privy Slab, made from concrete, is useful for large-scale privy programs. The slab, which includes a bowl and trap, is used to cover an ordinary pit privy. It comes from a long-established privy program in Thailand.

Master molds for the bowl and trap are used to make secondary molds from which the bowl and trap are actually made. The master molds can be made from the plans in the entry which follows. The master molds can sometimes be purchased from local health officers. In Thailand, they can be purchased from the Village Health and Sanitation Project, Ministry of Public Health, Bangkok.

The finished slab is quite strong because its three parts are cast at the same time (see Figure 10). The method described here can be applied to other water-seal slab designs.

Tools and Materials

Master molds

Materials for making concrete

Wood for platform forms

Reinforcing rod and wire

Clay

Crankcase oil

Beeswax and kerosene (optional)

Steel bars: 19mm x 19mm x 7.5cm
(3/4" x 3/4" x 5")

The basic method for making these water-seal slabs is to cast the slab, bowl, and water-seal trap using three forms:

1. A wooden form for shaping the slab (see Figure 6).
2. A concrete bowl core for shaping the inside of the bowl (see Figure 3).
3. A concrete core for shaping the inside of the water-seal trap (see Figure 9).

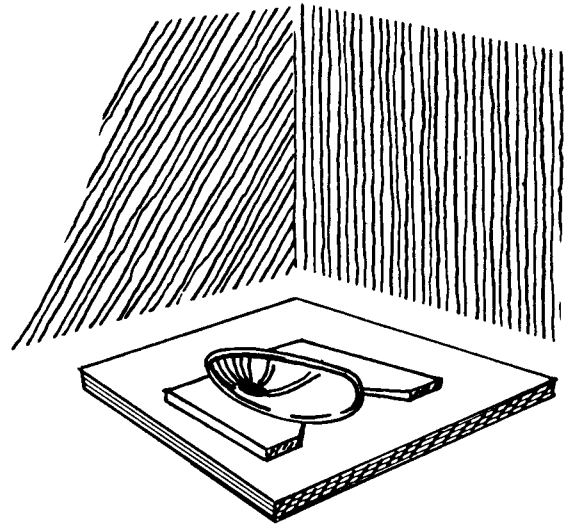

FIGURE 1
SKETCH OF FINISHED PRIVY.

3. A concrete core for shaping the inside of the water-seal trap (see Figure 9).

The water-seal trap is curved back under the bowl as shown in Figure 2a.

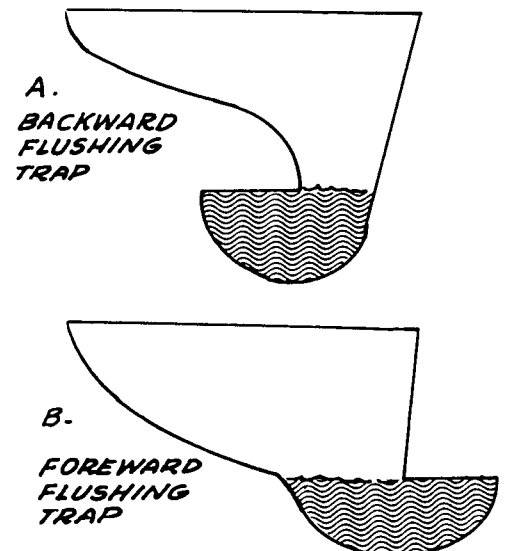

FIGURE 2. WATER SEAL TRAPS

This makes flushing more difficult, but prevents erosion of the back of the pit on loose soil. The same general method could be used to make a forward flushing trap (see Figure 2b).

The forms used when making a slab must stay in place until the concrete is strong enough, usually 24 hours. For this reason, many sets of forms are necessary if a reasonable number of slabs are to be cast every day. Here is where the three master molds are needed: one of them to cast the bowl core, and the other two to cast the trap core (see Figures 14 and 18).

Casting the Bowl Core

1. Oil the inside of the master bowl mold and insert a 19mm x 19mm x 7.5cm (3/4" x 3/4" x 5") steel bar into the bottom.
2. Add a fairly loose mixture of cement and water, called neat cement, to a depth of about (6"). Then fill to brim with a 1:1 cement-sand mixture. The 1:1 should be firm, not runny, and should be laid into the loose neat cement without stirring to insure a smooth finish on the bowl core.

3. After the bowl core has become firm enough, scoop a depression into the surface to install two steel hooks made from the reinforcing rod. They should be about 22.5cm (9") apart, and should not protrude above the surface of the concrete. See Figure 3.

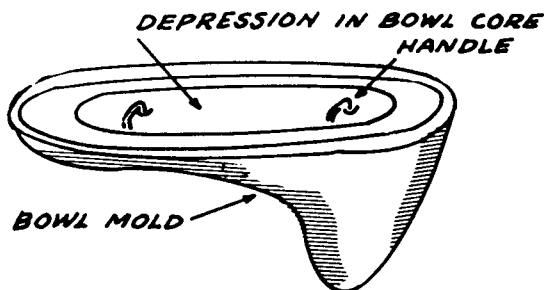

FIGURE 3 BOWL CORE HANDLES

4. Let the concrete set at least 24 hours before removing the bowl core from the master mold. The bowl core can be used to make another master mold and the master mold can be used to make more cores.

Casting the Trap Core

1. Add about 2.5cm (1") of 1:1 cement-sand mix to the oiled trap master mold and put in some wire for reinforcing. Then fill it with 1:1 almost to the brim. See Figure 4.

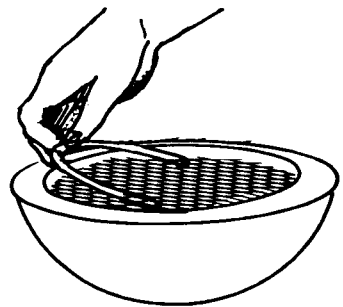

FIGURE 4 REINFORCING THE TRAP CORE

2. Put the oiled insert mold into place and scrape off excess. See Figure 5.

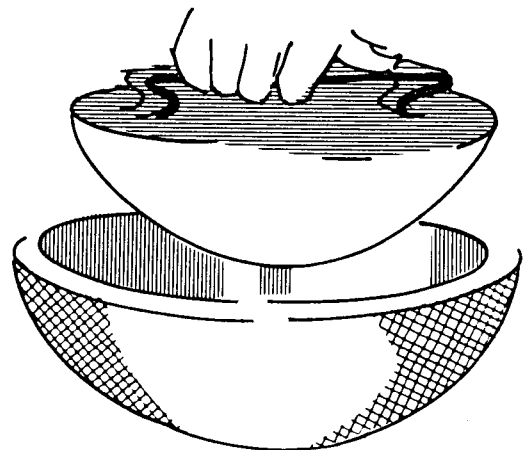

FIGURE 5 PLACING THE INSERT MOLD

3. After 45 minutes, remove the insert and put a square sheet metal pipe 19mm (3/4") high into the cubical indentation left by the insert. The pipe is made by wrapping sheet metal around a 19mm x 19mm (3/4" x 3/4") steel bar. Let the concrete dry in the mold for 24 hours.

4. Remove the finished trap core by tapping the master mold gently with a wooden block.

Making the Wooden Slab Form

1. Make a wooden platform 90cm x 90cm (35 1/2" x 35 1/2") out of 2.5cm (1") thick planks.

2. Cut out of the platform a hole 10cm x 33cm (4" x 13") for the hooks of the bowl core to extend into. The back of the hole should be 28cm (11") from the back of the platform. To determine the location of this hole, draw the outline of the bottom of the bowl on the platform, with the back of the bowl outline 23cm (9") from the back of the platform. (See Figure 6.) The back of the hole should be 28cm (11") from the back of the platform.

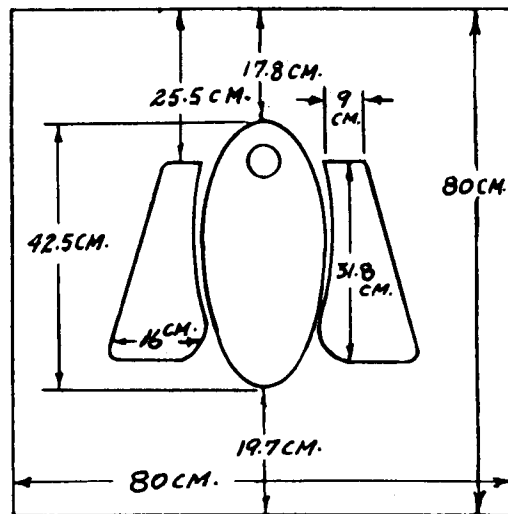

FIGURE 6 PRIVY SLAB OUTLINE

3. Using 38mm x 38mm (1 1/2" x 1 1/2") wood, make a frame with inside dimensions of 80cm x 80cm (31 1/2" x 31 1/2"). (See Figure 7.)

4. Gouge out the footrests with a wood chisel. The inside of the footrests should be about 12.5mm (1/2") from the outline of the bowl.

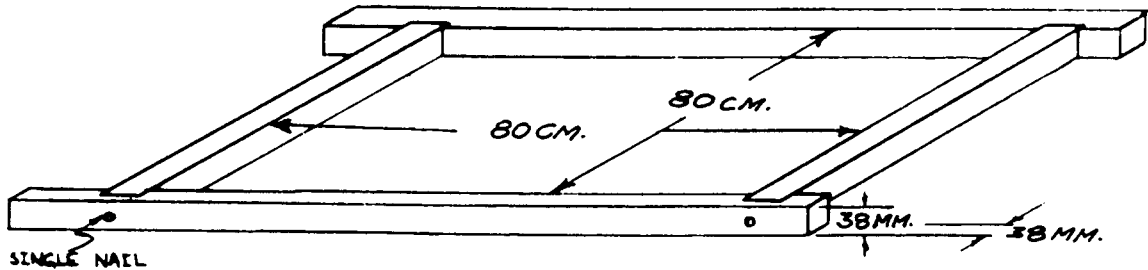

FIGURE 7 FRAME

Casting the Slab

With these three forms finished, you are ready to cast the first water-seal slab.

1. Use a paintbrush to coat the bowl core and the trap core with a layer of wax about 3mm (1/8") thick. Prepare the wax by dissolving 1kg (2.2 pounds) of melted beeswax in 0.5 liter (1 pint) of kerosene. The wax coating will last 5 to 6 castings adding U.S. \$0.01 to the cost of each slab. Wax makes removing the cores much easier, but it is not absolutely necessary. Let it dry before oiling.

2. Place the bowl core on the wooden slab form and fill all cracks with clay. See Figure 8.

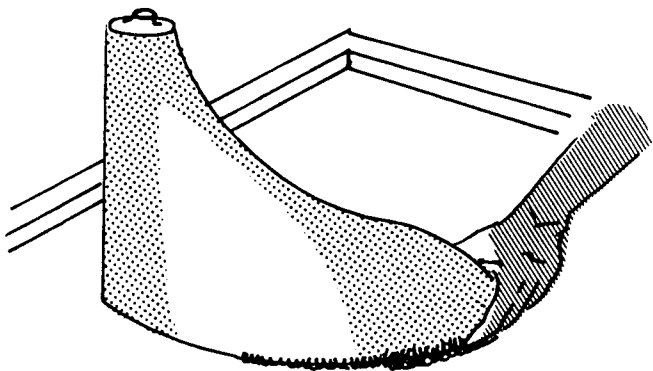

FIGURE 8. SEALING CRACKS WITH CLAY.

3. Oil the bowl, platform and frame.

4. Apply a 6mm (1/4") thick coat of pasty cement and water mixture to the bowl core and platform. (Many Thai people prefer to spend U.S. \$0.25 more for an attractive polished slab. To do this, instead of using a mixture of cement and water, use a mix

of 5 cement: 5 color: 1 granite chips. After the forms are removed, polish with a carborundum stone and plenty of water.)

5. Cover the bowl core with a 1:2 cement-sand mixture to a total thickness of 12.5mm (1/2"). Make a smooth lip on the cement 10mm (3/8") from the top of the bowl core as in Figure 9. This lip is your water seal. Use fairly dry cement and let it set for 15 minutes before cutting this lip.

6. Place the trap core on the bowl core and seal the crack with clay. Also add a little clay on each side of the form (near the thumb in Figure 9) to prevent cement from getting to the front lip.

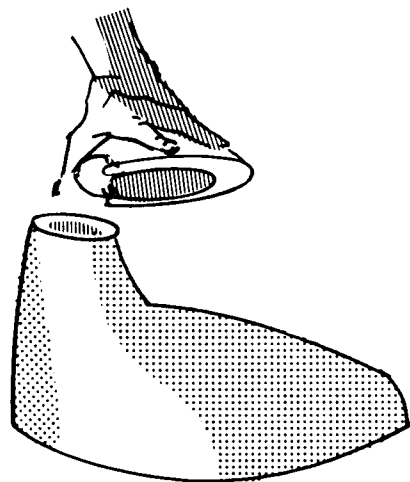

FIGURE 9. MOUNTING THE TRAP CORE.

7. Cover with 1:2 cement-sand mixture to a thickness of 12.5mm (1/2"). Do not exceed the 12.5mm (1/2") thickness below the trap core or you will not be able to remove this core.

8. Fill the slab form with a mixture of 1 cement: 2 sand: 3 clean gravel or crushed rock almost to the top. In preparing the concrete, first mix cement and sand, then add gravel and water. Use water conservatively. The looser the mix-

ture, the weaker the concrete will be.

9. Press in 4 pieces of 6mm (1/4") steel reinforcing rod. See Figure 10.

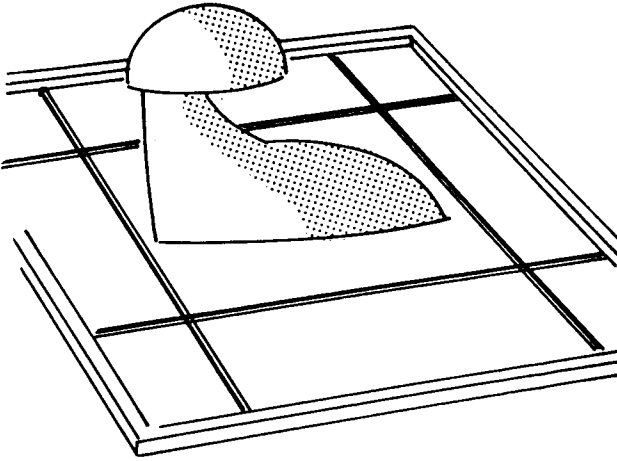

FIGURE 10. PLACING REINFORCING ROD.

10. Fill to top of frame and smooth. Allow at least 24 hours for setting.

11. Remove the frame by tapping lightly with hammer.

12. Turn the slab form over on a wooden stand and use simple levers to remove the bowl core. You must remove the bowl core before the trap core. See Figure 11.

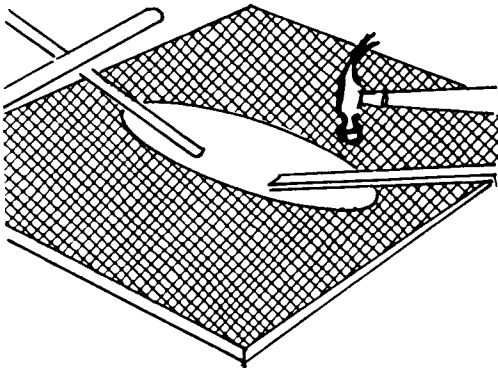

FIGURE 11. REMOVING THE BOWL CORE.

13. Tap the trap core gently and slip it out. Add a little water and check to see if your seal is 10mm (3/8").

14. Keep the slab damp and covered for a minimum of 3 days and preferably a week to gain strength.

Source:

Thailand's Water-Seal Privy Program,
by Barry Karlin, MPH, Sanitation
Advisor, USOM/Korat, Thailand.

MASTER MOLDS FOR THE THAILAND WATER-SEAL PRIVY SLAB

This entry describes how to make the three master molds from which cores can be cast. The cores in turn are used for casting Thailand Water-Seal Privy Slabs.

Tools and Materials

Cardboard

Materials for making concrete

Steel rod, 19mm (3/4") square

Sheet metal (tin-can metal is satisfactory)

Reinforcing wire

Clay

Oil (used crankcase oil is satisfactory)

Paint brush

Making the Master Molds

It may be necessary to make master molds rather than to purchase them. Study the entry "Thailand Water-Seal Privy Slab" before starting to make these master molds:

1. The Master Bowl Mold,
2. The Master Trap Mold, and
3. The Trap Mold Insert.

Making the Master Bowl Mold

1. Cut out profiles of the bowl outline from Figure 13, which is full size.
2. Shape a mound of clay using the cardboard profiles as a guide.
3. Form a little square pipe, 19mm (3/4") long, of sheet metal on the 19mm (3/4") square steel rod. Make several of these as they will be used later when casting the cores. Fill the square pipe with clay and press it into the top of the clay mound a little bit. This will be used later to "key" the cores together. See Figure 12.
4. Use a paint brush to paint the

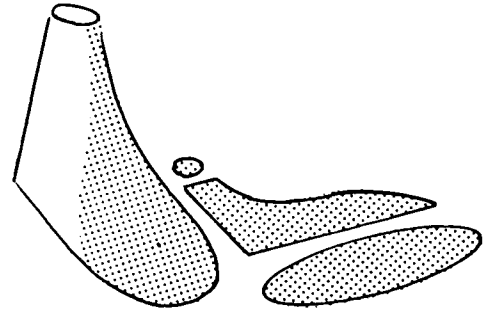

FIGURE 12. CLAY MOUND

clay mound with oil; old crankcase oil is fine.

5. Cover the clay mound with a stiff mixture of cement and water to a thickness of 12.5mm (1/2"). If the clay mound was properly prepared, the inside finish of the bowl mold will need no further smoothing.

6. After this cement has set 30 minutes, build up the thickness to 38mm (1 1/2") with 1:1 cement-sand mix. Let this set 24 hours and carefully lift the finished master bowl mold from the clay mound. The finished bowl mold is shown in Figure 14.

Making the Master Trap Mold

1. Make cardboard profiles of the trap from Figure 17, which is full size. Shape the outside of the trap from clay, and let it harden overnight.
2. Shape the under side by hand with a trowel using Figure 15 and the insert profile from Figure 17 as guides. Mark the location for a 19mm (3/4") square metal pipe by holding the clay trap over the clay mound used to shape the bowl mold, and letting the square sheet metal cube mark the trap.
3. Insert the sheet metal pipe into the clay trap and scoop out the clay

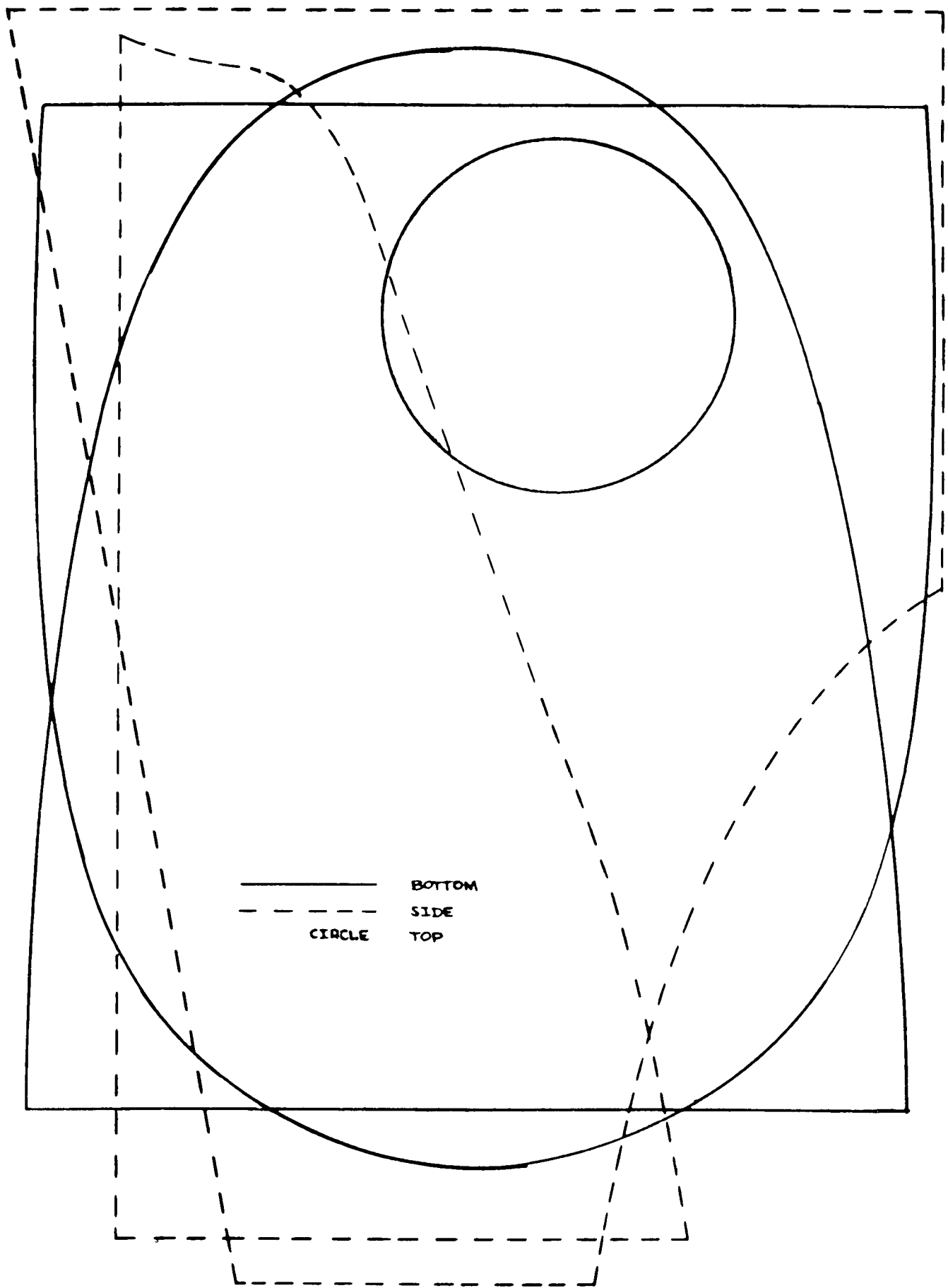
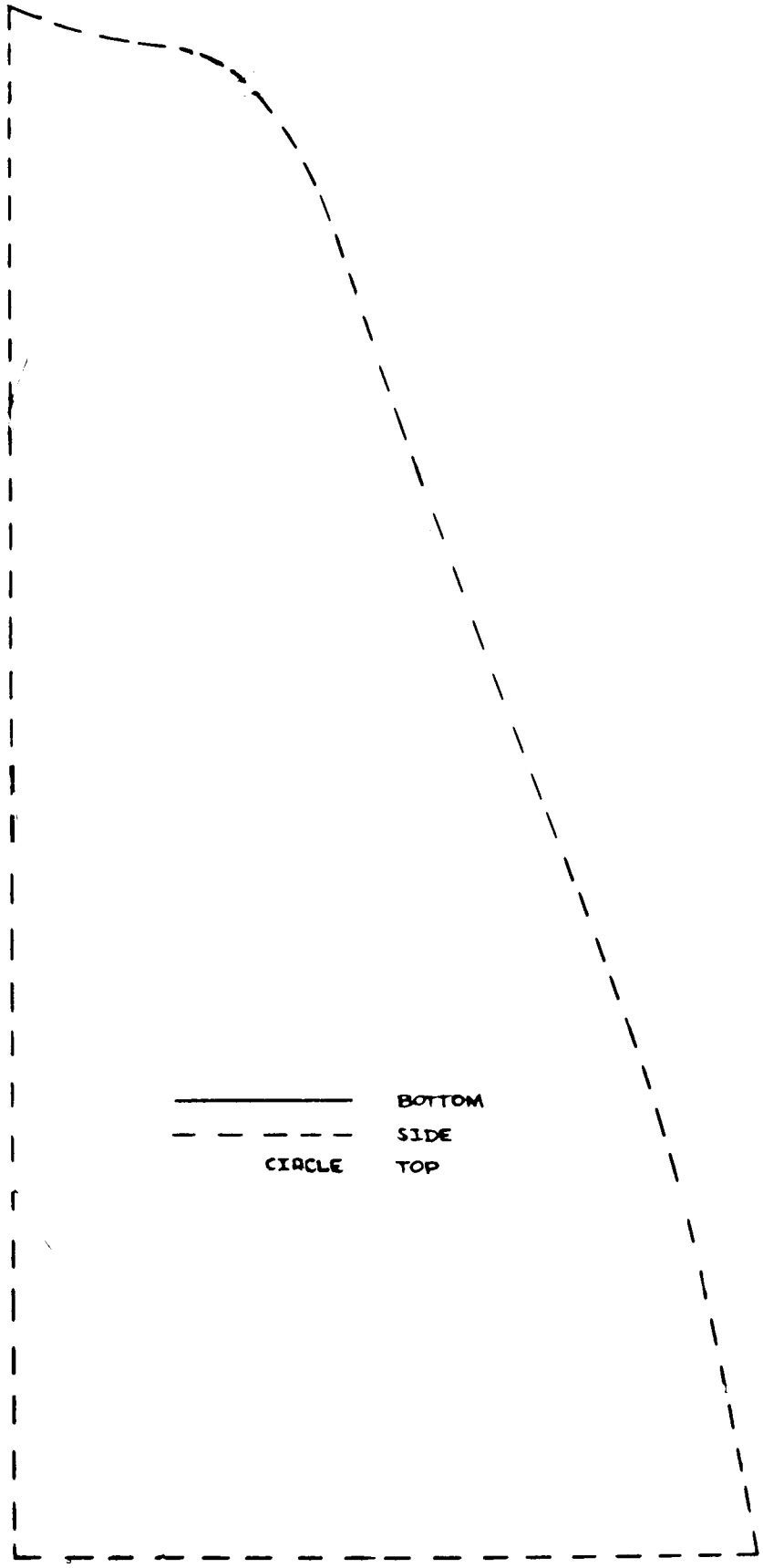
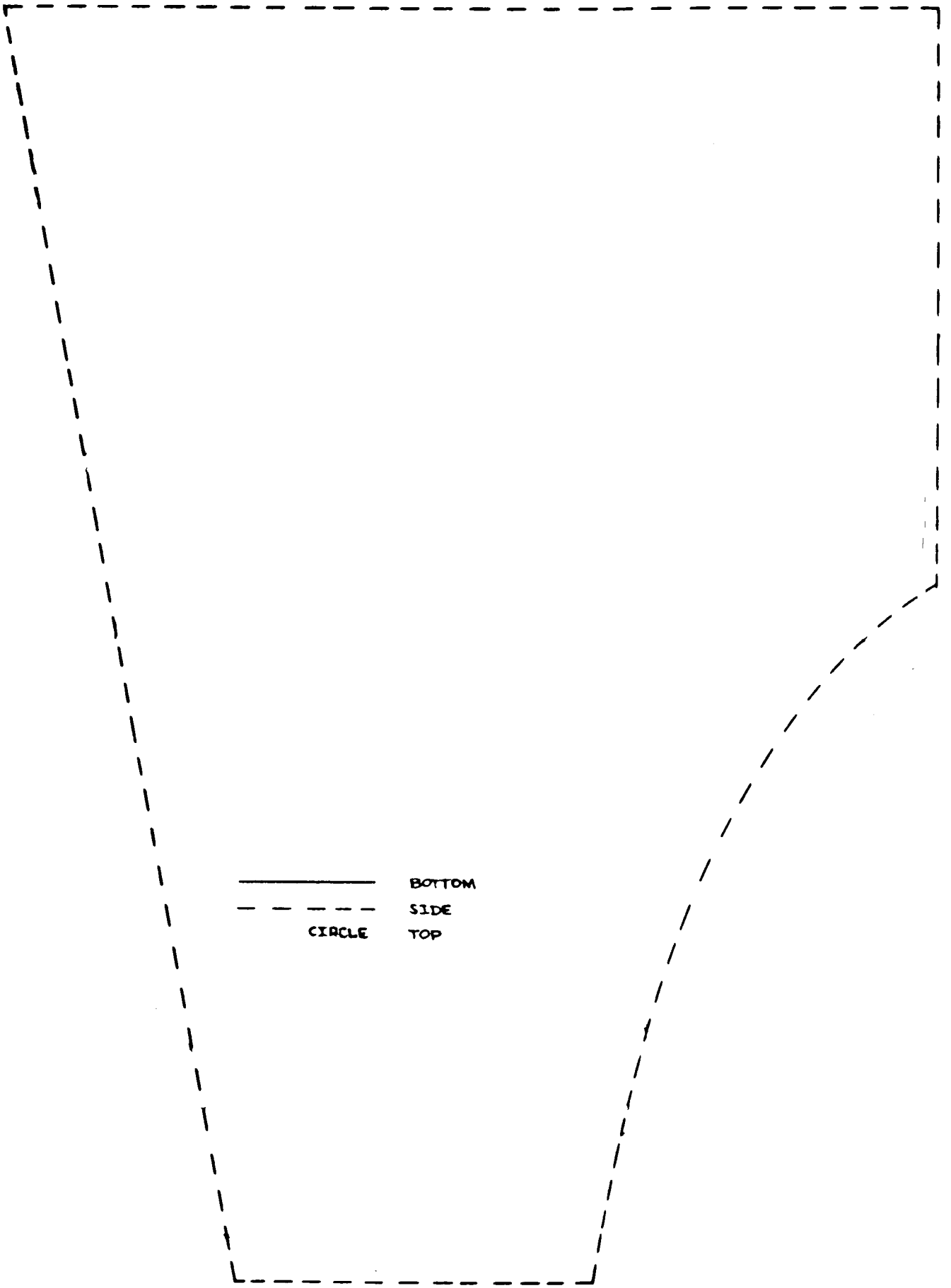

FIGURE 13. PROFILES FOR MAKING MASTER MOLD FOR BOWL (FULL SIZE)



— BOTTOM
- - - SIDE
CIRCLE TOP



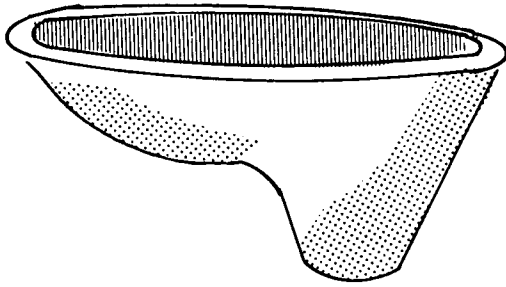

FIGURE 14. BOWL MOLD

from inside. See Figure 15. Check the clay trap on the bowl mound again to be sure it lines up properly.

4. Oil the clay trap.

5. Put a heel-shaped piece of clay under the clay trap and trim the sides. This will prevent the cement from running under the mold. See Figure 16.

6. Cover with cement and water to 19mm (3/4"), add steel reinforcing wire, and cover with 19mm (3/4") more of 1:1 cement-sand mixture.

7. Flatten the top and insert wire handles. Let it set at least 24 hours. This completes the master trap mold.

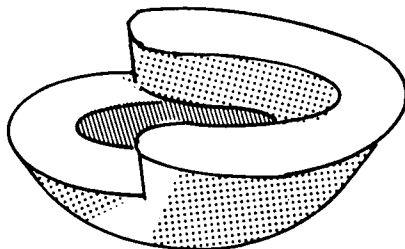
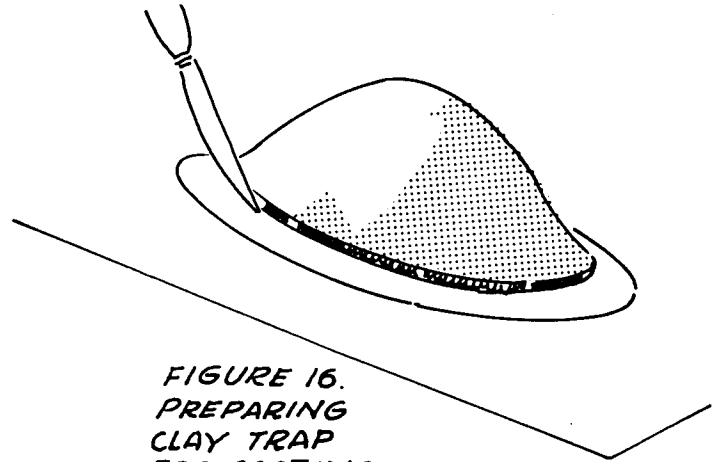

FIGURE 15. CLAY TRAP



*FIGURE 16.
PREPARING
CLAY TRAP
FOR CASTING MOLD*

Making the Trap Mold Insert

1. Turn the master trap mold over carefully, and remove the heel-shaped clay plug.
2. Oil all inner surfaces and fill to the brim with 1:1 cement-sand mix.
3. Insert a small wire handle and let the concrete set for at least 24 hours before separating the finished molds.

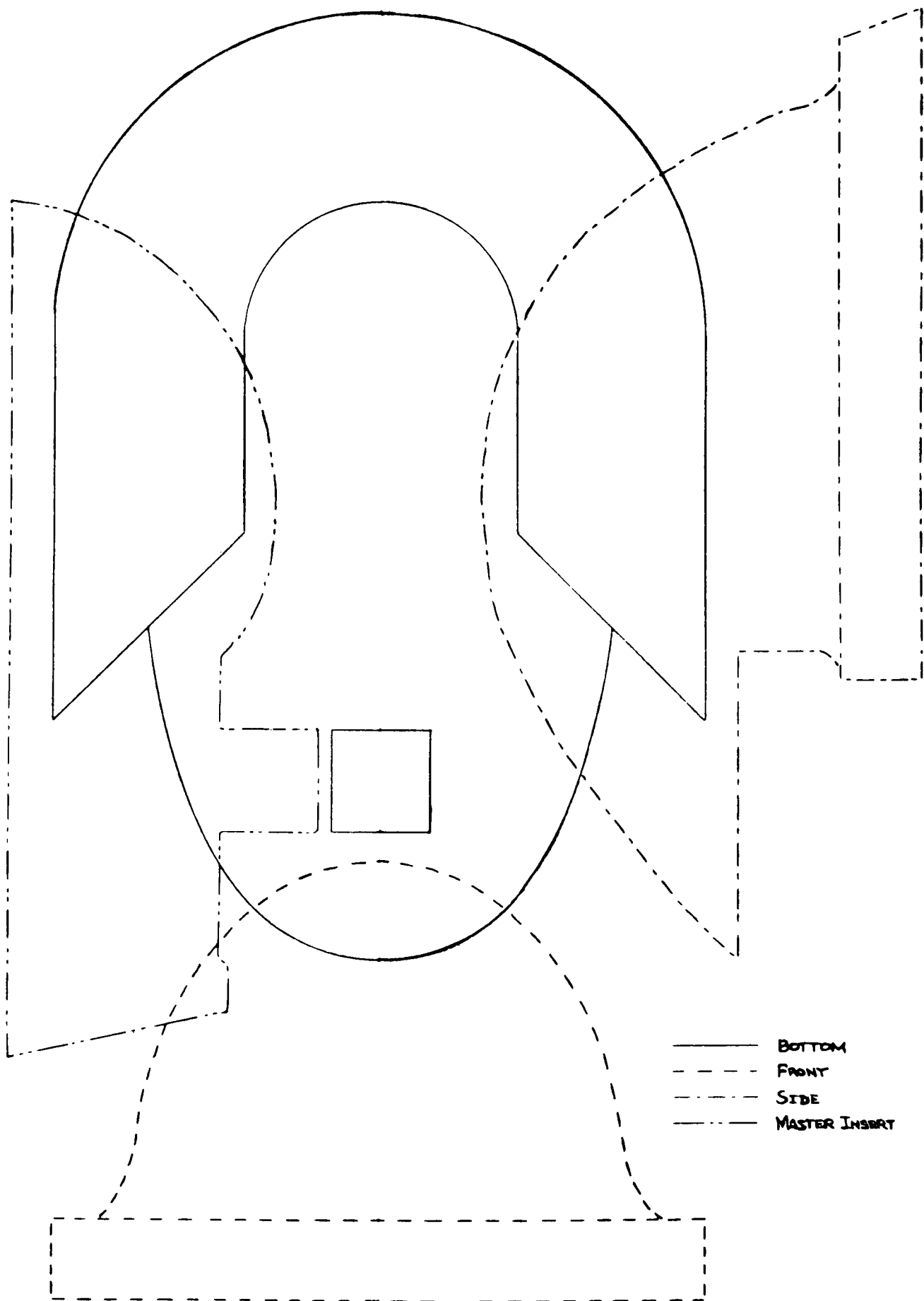
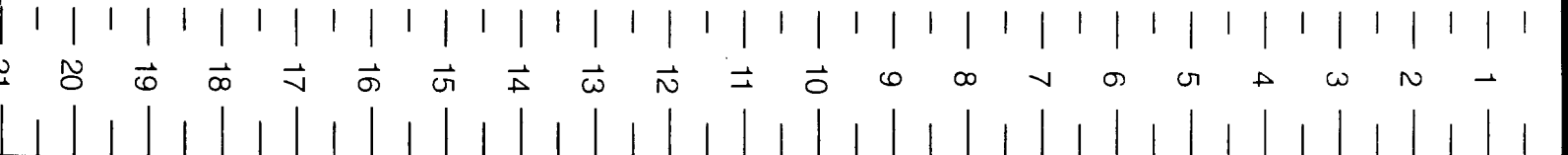
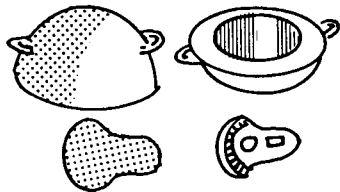

FIGURE 17. PROFILES FOR MAKING MASTER MOLDS FOR TRAP (FULL SIZE)



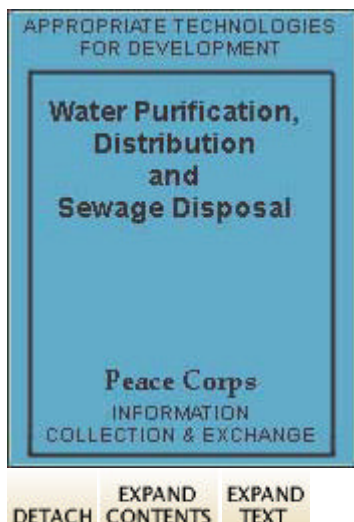

*FIGURE 18. TRAP MOLD
AND INSERT*

Source:

Thailand's Water-Seal Privy Program,
by Barry Karlin, MPH Sanitation
Advisor, USOM/Korat, Thailand.

Figure 18 shows the completed master trap mold and insert.

[search](#)[subjects](#)[titles a-z](#)[organization](#)[how to](#)

Water purification, distribution and sewage disposal for Peace Corps volunteers



Section 8: The privy method of excreta disposal design for a village



Overview:



The sanitary survey



The pit privy



Example privy designs



Latrine for village use



Thailand water-seal privy



Lesson plans



Thailand water-seal privy

This concrete water-seal slab is most useful for wide-scale privy programs. It is used to cover an ordinary pit privy. This method represents the collected experience of a long established privy program in Thailand. The general method should be applicable to other water-seal slab designs.

Tools and Materials

Master molds - Can be purchased from Village Health and Sanitation Project, Ministry of Public Health, Department of Health, Bangkok, Thailand. This aluminum master mold weighs 24 pounds and costs \$7.50 plus shipping charges.

Concrete making materials

Wood for platform forms

Reinforcing rod and wire

Clay

Crankcase oil

Beeswax and kerosene (optional)

3/4" x 3/4" x 5" steel bars

The basic method used for making these water-seal slabs is to cast the slab, bowl, and water-seal trap using three forms :

1. A wooden form for shaping the slab.
2. A concrete bowl core for shaping the inside of the bowl.
3. A concrete core for shaping the inside of the water-seal trap.

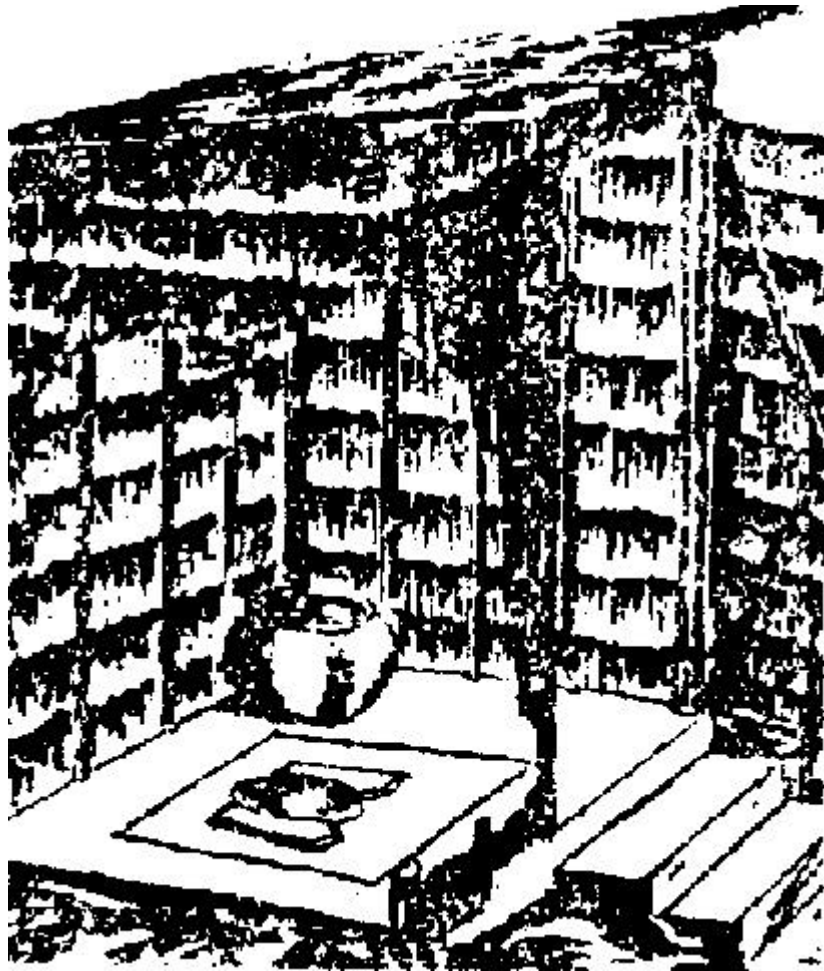

Fig. 82 Sketch of Finished **Privy**

Since the three parts of the slab are all cast at one time, the finished **privy** slab is quite strong. The water-seal trap is curved back under the bowl as shown in Fig. 83 A

This makes flushing more difficult, but prevents erosion of the back of the pit on loose soil. The same general method could be used to make a forward flushing trap, Fig. 83 B.

The forms used when making a slab must stay in place till the concrete has gained enough strength to allow their removal. This is usually 24 hours. For this reason, many sets of forms are necessary if a reasonable number of slabs are to be cast every day. Here is where the master molds are needed. One is used to cast the bowl core, and two are needed to cast the trap core.

Casting the Bowl Core

1. Oil the inside of the master bowl mold and insert a 3/4" x 3/4" x 5" steel bar into the bottom.
2. Add a fairly loose mixture of cement and water, called neat cement, to a depth of about 6". Then fill to brim with a 1:1 cement sand mixture. The 1:1 should be firm, not runny, and should be laid into the loose neat cement without stirring to insure a smooth finish on the bowl core.
3. After the bowl core has become firm enough, scoop a depression into the surface to install the two steel hooks made from the reinforcing rod. They should be about 9" apart, and should not protrude above the surface of the concrete. See Fig.
4. Allow the concrete to set at least 24 hours before removing the bowl core from the master mold.

The bowl core can be used to make another master mole and vice versa.

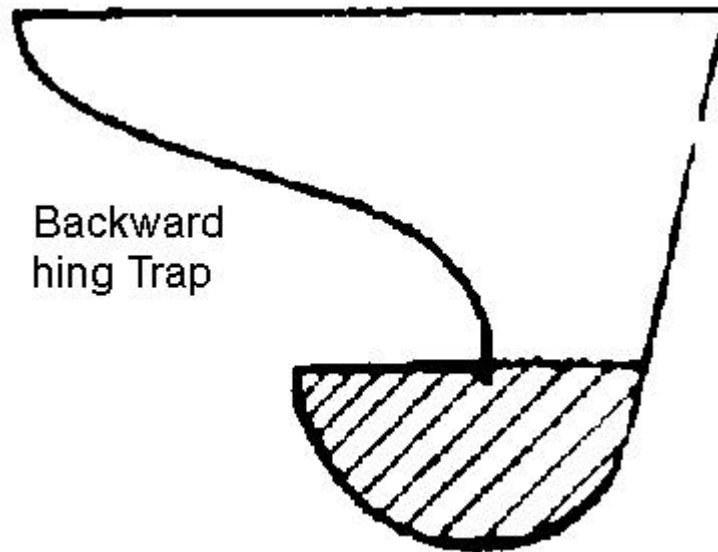

Fig. 83A Backward Flushing Trap

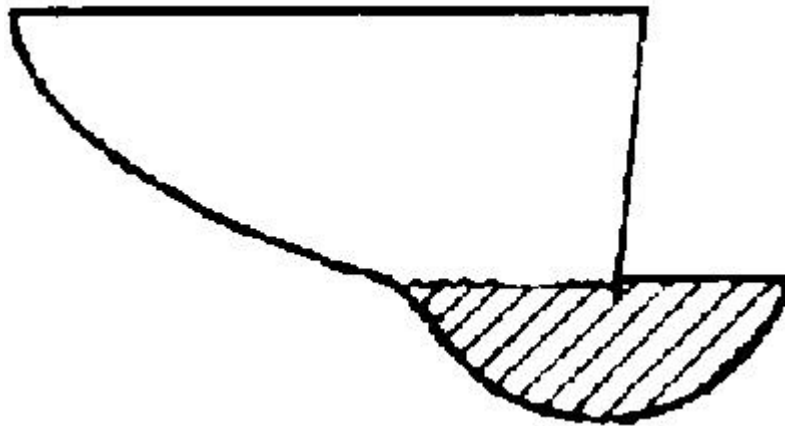

Fig. 83B Forward Flushing Trap

Casting the Trap Core

Make the trap core using the pair of master molds, which consist of the trap master mold and the insert mold.

1. Add about 1" of 1:1 cement sand mix to the oiled trap master mold and put in some wire for reinforcing. Then fill it with 1:1 almost to the brim.
2. Put the oiled insert mold into place and scrape off excess.
3. After 45 minutes remove the insert and add a square sheet metal pipe 3/4" high made by wrapping sheet metal around a 3/4" x 3/4" steel bar.
4. Remove the finished trap core by gently tapping the master mold with a wooden block

Construction of the Wooden Slab Form

1. Make a frame of 1 1/2" x 1 1/2" wood with an inside diameter of 80 cm x 80 cm. A notch and single nail on each corner works we 1. See Fig. 86 .

2. Make a wooden platform 90 cm x 90 cm out of 1" thick planks. Gouge 1/2" deep footrests if these are desired. See the outline in Fig.

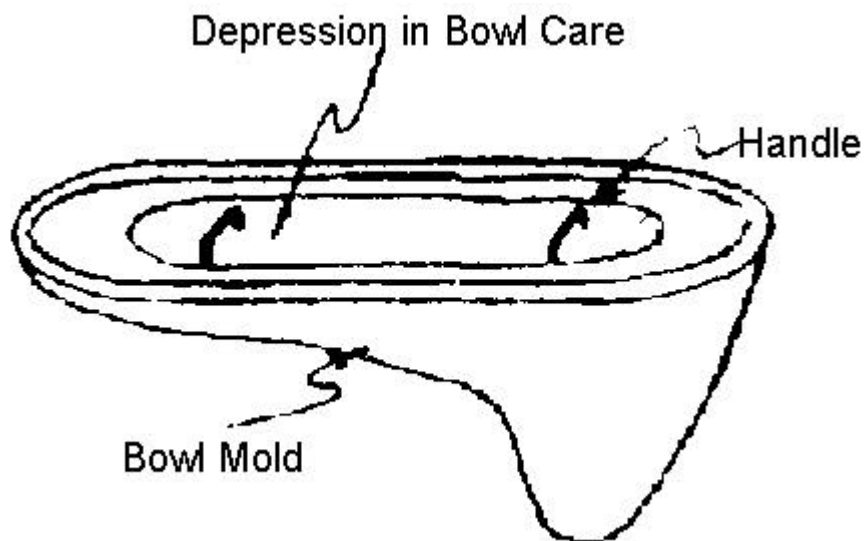

Fig. 84 Bowl Core Handles

Casting the Slab

With these three forms finished you are ready to cast the first water-seal slab.

1. Use a paint brush to coat the bowl core and the trap core with a layer of wax about 1/8" thick. Prepare the wax by dissolving 1 kilogram of melted beeswax in 1/2 liter of kerosene. The wax coating will last 5 or 6 castings adding it to the cost of each slab. Wax makes removing the cores much easier, but isn't absolutely necessary.

2. Place the bowl core on the wooden slab form and fill all cracks with clay.

3 Oil the bowl, platform and frame.

4. Apply a 1/4" thick coat of pasty cement and water mixture to the bowl core and platform. (Many Thai people prefer to spend 25¢ more for an attractive polished slab. To do this, instead of using a mixture of cement and water, use a mix of 5 cement : 5 color : 1 granite chips. After tile forms are removed, polish with a carborundum stone and plenty of water).

5. Cover the bowl core with a mixture of 1 cement : 2 sand, to total thickness of 1/2". Notice the smooth lip made on the cement 3/8" from the top of the bowl core. This lip is your water-seal. Use fairly dry cement and allow it to set for 15 minutes before cutting this lip.

6. Place the trap core on the bowl core and seal the crack with clay. Also add a little clay on each side of the form to prevent cement from getting to the front lip.

7. Cover with 1 : 2 cement sand mixture to a thickness of 1/2". Do not exceed the 1/2" thickness below the trap core or you will not be able to remove this core.

8. Fill the slab form with a mixture of 1 cement : 2 sand 3 clean gravel or crushed rock almost to the top. In preparing the concrete, first mix cement and sand, then add gravel and water. Use water conservatively. The looser the mixture, the weaker the concrete will be.

9. Press In 4 pieces of 1/4" steel rod reinforcing.
10. Fill to top of frame and smooth. Allow at least 24 hours for setting.
11. Remove the frame by tapping lightly with hammer.
12. Turn the slab form over on a wooden stand and use simple levers to remove the bowl core. You must remove the bowl core before the trap core.
13. Tap the trap core gently and slip it out. Add a little water and check to see if your seal is 3/8".
14. Keep the slab damp and covered for a minimum of 3 days and preferably a week to gain strength.

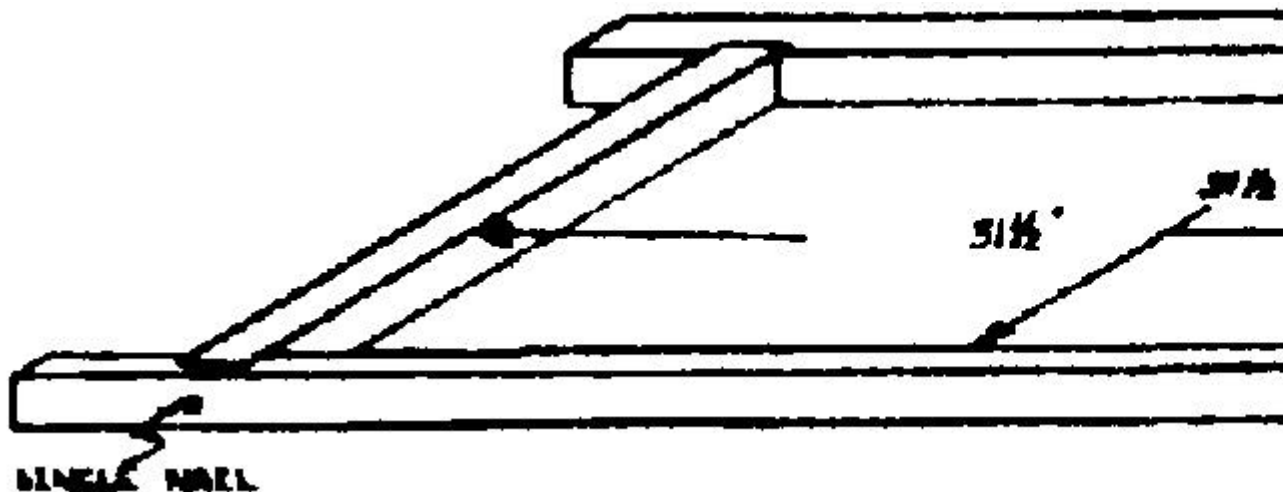

Fig. 85 Privy Frame

14. Keep the slab damp and covered for a minimum of 3 days and preferably a week to gain strength.

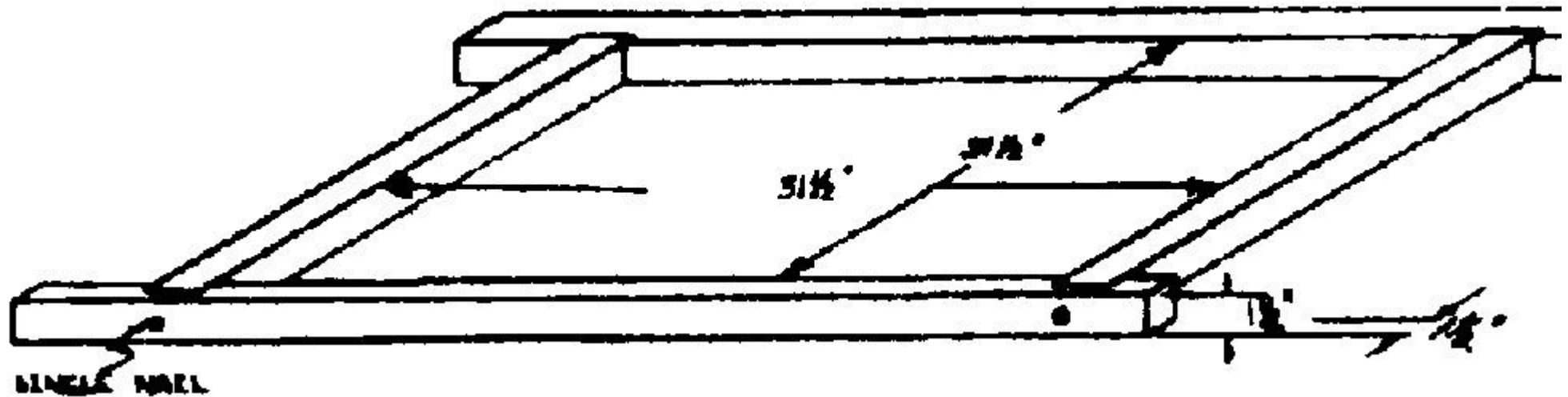

Fig. 85 Privy Frame

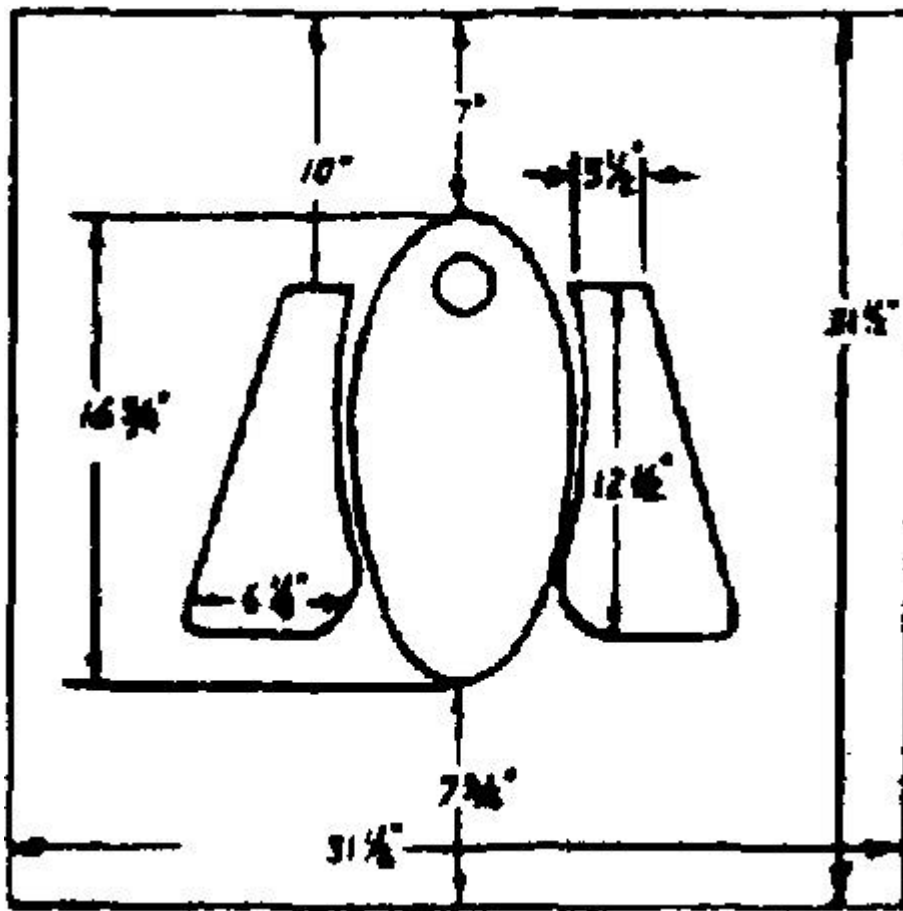
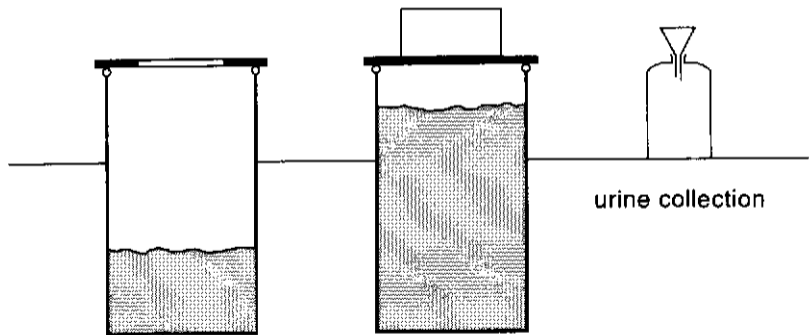

Fig. 86 **Privy** Slab Outline

[View this page in text format](#)

The Pit Privy

ash container



pit in use

sealed pit

urine collection

Little Extras that Make Privies more Pleasurable.

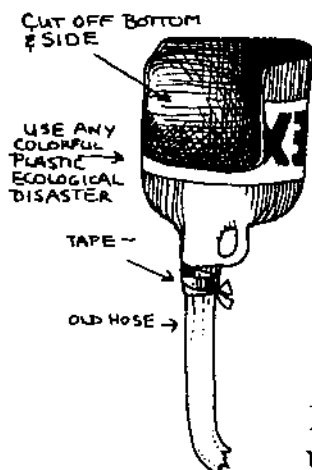

HOMEMADE URINAL -
IF YR TIRED O ALL THEM SPLATTERS ON THE outhouse SEAT, MAKE ONE O THESE E SINK THE HOSE THROUGH THE FLOOR. MOUNT ON THE WALL AT "HOSE" LEVEL.

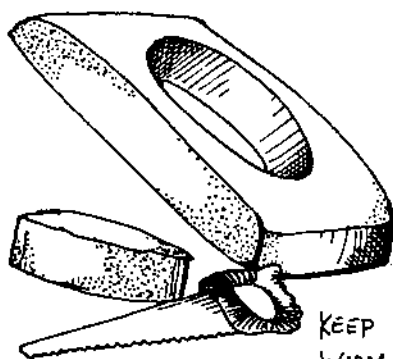

KEEP YR BUM WARM IN THOSE COLD WINTRY DAYS WITH A SEAT MADE OF STYROFOAM. HEATS UP WHEN YA SIT ON IT.

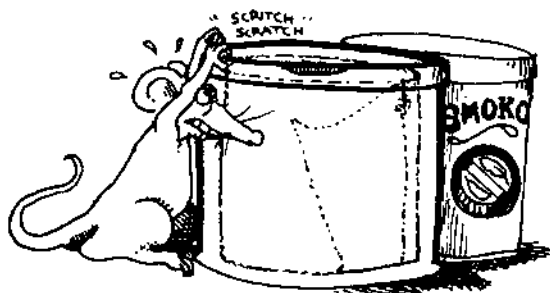

SAVE THEM OLD TOBACCA AND COFFEE CANS. THEY MAKE GREAT CONTAINERS FOR TOILET PAPER