**ASSESSMENT OF THE COMMERCIAL POTENTIAL
FOR SMALL GASIFICATION COMBINED CYCLE
AND FUEL CELL SYSTEMS
PHASE II FINAL DRAFT REPORT**

**Prepared by:
HM Associates Inc.
Princeton Energy Resources International, LLC
And
TFB Consulting**

**Prepared for:
U.S. Department of Energy
Office of Fossil Energy
Office of Coal and Power Systems**

March 2003

PREFACE

This activity was initiated by the U.S. Department of Energy, Office of Fossil Energy to investigate and identify RD&D needs that could result in accelerating commercial acceptance of small-scale (10-50 MW) electric power generation systems utilizing gasification technology.

The investigation team consisted of John Rezaian, Thomas Bechtel, Harvey Weisenfeld, and Nicholas Cheremisinoff. The investigation team also wishes to thank Dr. Lowell Miller, Office of Fossil Energy, Coal and Power Systems, for his invaluable guidance and review of the draft report.

Table of Contents

<u>Section and Title</u>	<u>Page</u>
1. Executive Summary.....	1
2. Introduction.....	5
3. Gasification State-Of-The Art And Performance Benchmarks.....	7
3.1 Overview Of Gasification Technologies.....	7
3.2 Coal Gasification Technology.....	9
3.2.1 Entrained-flow Gasifiers.....	11
3.2.2 Fluidized-Bed Gasifiers.....	12
3.2.3 Fixed-Bed Gasifiers.....	13
3.3 Biomass Gasification Technology.....	14
3.3.1 Updraft Gasifiers.....	15
3.3.2 Downdraft Gasifiers.....	15
3.3.3 Bubbling Fluidized-Bed Gasifiers.....	15
3.3.4 Circulating Fluidized-Bed Gasifiers.....	17
3.4 Syngas Cooling and Cleaning Systems.....	17
4. Syngas Applications And Technology Selection Criteria.....	18
5. Syngas Applications For Power and Heat Generation	32
5.1 Conventional Power and Heat Generation.....	32
5.2 Integrated Gasification Combine Cycle (IGCC) Systems.....	32
5.3 Fuel Cell Systems.....	33
5.3.1 Integrated Gasification Fuel Cell (IGFC) Systems.....	35
6. Conclusions.....	40
7. Recommendations.....	44
Appendix I - Coal Gasification Technologies.....	45

List of Figures

Figure Number And Title	Page
1.1 Power Generation Technologies Capital And Fuel Costs Matrix	2
1.2 Power Generation Technologies Capital Cost, Fuel Cost, And Emission Reduction Matrix.....	2
3.1 Coal Gasification Technologies And Classifications.....	10
3.2 Biomass Gasification Technologies and Classifications.....	16
4.1 Logic Diagram For Screening And Matching Different Gasification Technologies and End Use Applications.....	30
5.1 Fuel Cell Concept.....	34
5.2 Examples Of Natural Gas Based Basic Fuel Cell Systems.....	36
5.3 Low Pressure Hybrid Fuel Cell Systems.....	37
5.4 High Pressure Hybrid Fuel Cell Systems.....	38
5.5 Advanced Fuel Cell Hybrid System.....	39
6.1 Power Generation Technologies Capital And Fuel Costs Matrix.....	41
6.2 Power Generation Technologies Capital Cost, Fuel Cost, And Emission Reduction Matrix.....	41

List of Tables

Table Number And Title	Page
3.1 Typical Characteristics of Coal Gasifiers.....	11
4.1 Desired Syngas Characteristics For Different End-Use Applications.....	19
4.2 Syngas Product Characteristics by Gasification Technology And Fuel Type.....	21
4.3 Key Operating Parameter Of Gasification Technologies.....	25

1. Executive Summary

The first phase of the subject assessment focused on how small, central gasification combined cycle systems could become cost competitive in the power generation market. The results indicated that the lowest cost gasification technology for this downscale application was the entrained reactor system being tested at the Power System Development Facility and that the break-even point was at the 300 MW level. This size gasification combined cycle plant is expected to be attractive to many of the independent power producers who are active in the contract and merchant plant markets. The report used the best available data to identify technical, environmental, and cost parameters of the various sub-systems required to construct a plant at that scale and the ongoing research needed to bring that concept to fruition.

There remains the question as to whether coal-based gasification technology can be a player in the distributed energy market at the size range of 10-50 MW, which is common in the industrial combined heat and power applications and where opportunity fuels are often of interest.

This Phase II effort focuses on the integration of appropriate small size gasification systems with potential fuel cell and fuel cell hybrid technology applications, with system operating pressures being driven by power generation economics.

This report has been prepared to help fossil energy policy developers and program managers to bring focus to the development of commercially viable, environmentally friendly, small (10-50 MW), coal-based distributed energy systems. One of the objectives of this report is identifying the most likely and least resistant path to commercialization for small-scale integrated gasification systems while meeting environmental constraints. This objective is based on the premise that the development of a commercially acceptable product would lead to evolutionary product improvements over time as commercialization of gas turbine and other energy products have proven. Another objective is to identify R&D efforts that could lead to “leap frog” advancement in commercialization of small scale, coal-based integrated gasification systems.

Figures 1 and 2 conceptually illustrate the relationship between fuel costs, capital costs, and various power generation systems emissions. Increasing public and government demand for more environmentally friendly power generation systems is driving the power generation industry to switch to cleaner and more expensive fuels such as natural gas and hydrogen. As the demand for cleaner and more expensive fuels increases, more efficient power generation systems are desired. However, these more efficient systems are also capital intensive. These increases in capital and fuel costs also favor larger, centralized power generation plants, at least initially.

Because of the economies of scale and the needs of the utility industry, most industry and government efforts in coal gasification are directed towards the development of large-scale, centralized power plants. ***Most IGCC R&D efforts also appear to be geared***

Figure 1.1 - Power Generation Technologies Capital And Fuel Costs Matrix

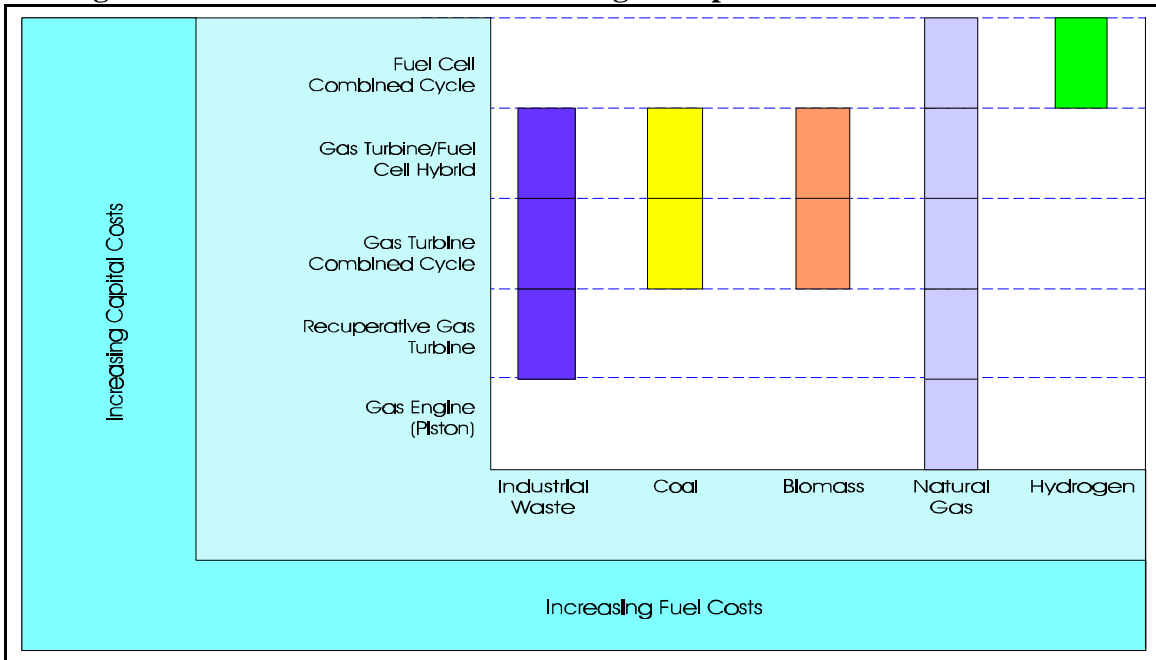
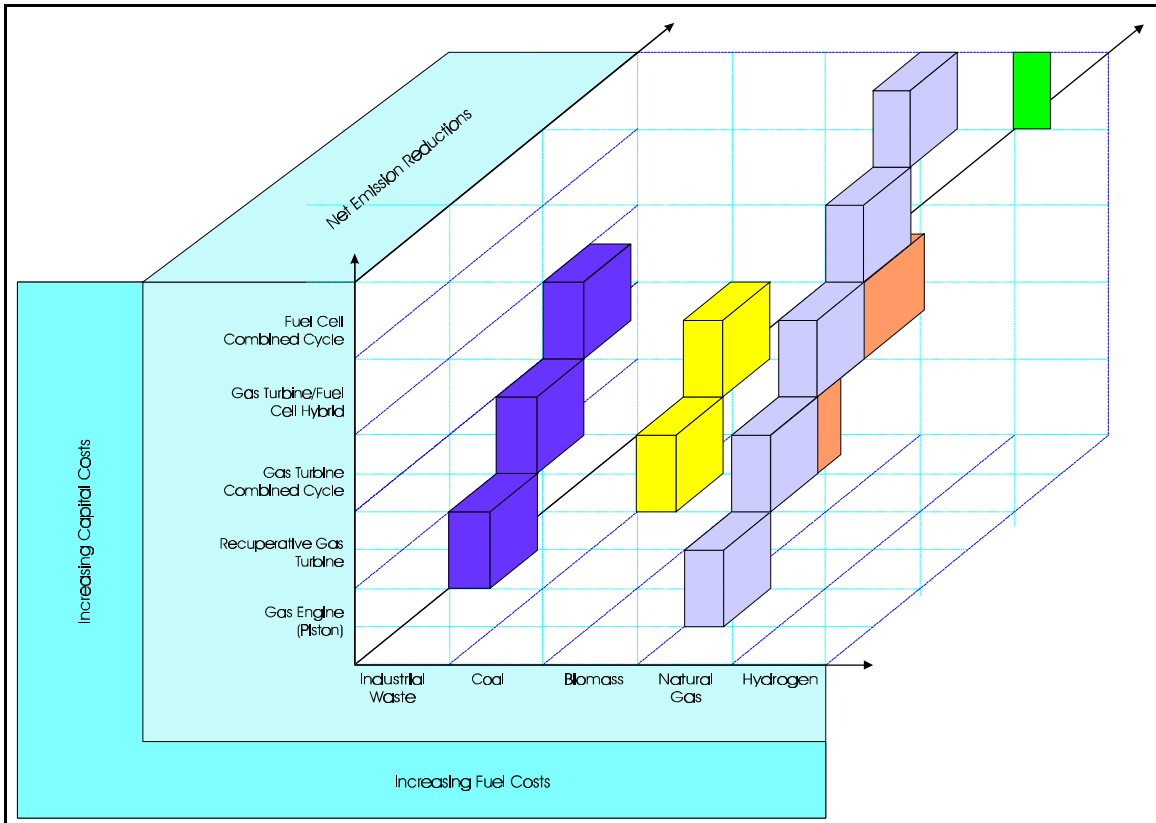

Figure 1.2 - Power Generation Technologies Capital Costs, Fuel Costs And Emission Reduction Matrix



towards improving the efficiency and economics of pressurized, oxygen blown, entrained-flow gasification systems, which are favored for large-scale power generation. R&D efforts for the development of fuel cell technology and for distributed power generation are primarily focused on natural gas- fueled systems.

Of all the small-scale gasification systems investigated, two appear to have the potential for competing commercially within the next decade. They are the MTCI and FERCO steam reforming processes. These systems do not require an oxygen separation unit and produce a hydrogen rich, medium-Btu syngas. System studies are needed to address optimal system configurations as well as fuel transportation, storage, and processing issues. Environmental performance of these systems is also expected to improve when coal and biomass are cogasified. Cogasification of coal and biomass can reduce the emission of CO₂, NO_x, and SO₂ and systems can be designed so that the total CO₂ emitted is the same as the amount of CO₂ that biomass absorbs in its growth.

Low temperature gas cleaning processes are commercially available, but amine-based systems may not be suited for fuel cell applications. High temperature or warm gas cleaning systems are being demonstrated but are not commercially available. The gas cleaning and syngas processing requirements will vary depending on the fuel cell type. *Integrated system studies are needed to address these issues and identify system components that could significantly reduce the overall system capital and operating costs.*

The economics of small-scale systems is expected to compete favorably against large centralized power plants where small-scale, distributed generation plants can benefit from the avoidance of transmission losses, or from unavailability, or the high cost of grid-connected power.

Since CO₂ sequestration may be required, several options need to be considered for minimizing, separating, and/or concentrating CO₂. These options include:

1. Removal of CO₂ from syngas without shifting CO and utilizing the remaining syngas (CO and H₂) in a combustion turbine or fuel cell. Using oxygen could further concentrate resulting the CO₂ in the combustion gases.
2. Shifting CO to CO₂, separating the CO₂, and utilizing the remaining syngas hydrogen as fuel for fuel cells.
3. Separate hydrogen from un-shifted syngas for fuel cell applications, or other uses, and firing the remaining syngas in a combustion turbine.

The technical and economic viability of these options will depend on the quality of the syngas and the end use-applications such as fuel cell type and CO₂ market or economic value. Recent reports indicate that a CO₂ credit of \$1.15 - \$25 per ton has been negotiated among some European countries under the Joint Implementation Program

To accelerate the commercialization of small-scale gasification systems, the following R&D activities are recommended for further consideration:

1. Conduct detailed system studies of the MTCI and FERCO systems to identify syngas cleaning and processing requirements and optimum system configurations.
2. Demonstrate fuel cell operations using steam reformer syngas.

The following R&D efforts could lead to “leap frog” advancement of coal-based distributed generation systems:

1. Continue development of high temperature gas cleaning and reforming process for gas turbine and high- pressure fuel cell applications.
3. Demonstrate coal/biomass steam reforming as an effective method for reducing CO₂.
2. Identify and evaluate hydrogen and CO₂ separation techniques and assess the technical and economic potential of “pre- and post- power generation” CO₂ removal approaches for hybrid fuel cell systems.
3. Evaluate the technical and economic merit of separating the hydrogen content of syngas and combusting the remaining gases with oxygen for gas turbine applications and concentrating the CO₂ for removal.
4. Develop strategies for addressing coal transportation, processing, and storage issues for small-scale, distributed generation systems.
5. Develop strategies for addressing syngas storage and transporting, and evaluate the potential use of current natural gas networks in conjunction with large, centralized, coal-based syngas production facilities.
6. Develop strategies for the development of storage and transportation systems, for hydrogen and other coal-derived fuels that can be easily processed for fuel cell applications at the point of use.

It is also recommended that follow-on efforts be implemented as noted below:

Conduct a series of meetings with senior managers at DOE’s Office of Fossil Energy and executives of selected gasifier and fuel cell developers and manufacturers, and utility and independent power producers to determine near-, mid-, and long-term market potential for and barriers to commercialization of the small-scale gasification systems as well as the economic incentives that could be adopted and the appropriate role that DOE could play to accelerate the market acceptance of these technologies.

2. Introduction

A previous report¹ assessed how small, central, gasification combined cycle systems could become cost competitive in the power generation market. The results indicated that the lowest cost gasification technology for this downscale application was the entrained reactor system being tested at the Power System Development Facility and that the break-even point was at the 300 MW level. This size gasification combined cycle plant is expected to be attractive to many of the independent power producers who are active in the contract and merchant plant markets. The report used the best available data to identify technical, environmental and cost parameters of the various sub-systems required to construct a plant at that scale and the ongoing research needed to bring that concept to fruition.

There remained the question as to whether coal-based gasification technology can be a player in the distributed energy market at the size range of 10-50 MW which is common in the industrial combined heat and power applications and where opportunity fuels are often of interest. Gasification technologies offer the potential to provide a stable, affordable energy supply for the United States. Gasification-based systems offer the promise of high efficiency with near zero pollution. Additionally, they offer flexibility in the production of a broad spectrum of products including electricity, fuels, chemicals, hydrogen, and steam; they also offer fuel flexibility. They can operate on low-cost and widely available feedstocks, which is highly critical in a time when electricity- and fuel-price fluctuations create instability. Capturing these benefits will require dedicated resources and financial commitments across a broad front of issues and needs.

The U.S. Department of Energy (DOE), Office of Fossil Energy's top priorities include:²

- Increasing efficiency of energy generation from fossil fuels,
- Eliminating greenhouse gas emissions from power plants,
- Providing access to advanced energy resources.

In particular, the Office of Coal and Power Systems within the Office of Fossil Energy is charged with better protecting America's environment by developing new, environmentally friendly technologies that improve the efficiency of power plants while reducing their environmental impact. Consistent with these goals and objectives of the DOE's Office of Fossil Energy and of the Office of Coal and Power Systems, this report focuses on the integration of appropriate small size gasification systems with potential fuel cell, fuel cell hybrid, or fuel cell combined cycle systems for distributed energy market applications. These systems not only have the potential to improve the efficiency of power and heat generation systems, but offer the promise of reducing environmental emissions including emission of particulates, NO_x, SO_x, and CO₂.

¹ "Phase I" Assessment of the Commercial Potential for Small Gasification Combine Cycle Systems, John Notestien, Energetics, Incorporated, April 2002.

² Office of Fossil Energy Top to Bottom Review, October 2002.

This report provides an in-depth assessment of the technical status of integrated coal gasification technologies with emphasis given to power generation. Gas turbine, fuel cell, and overall system integration requirements for coal gasification processes are discussed within the context of fully integrated systems. The report provides a critical review and roadmap of research issues and R&D needs that focus on commercialization for 10 to 50 MW range power systems. It is prepared to help fossil energy policy developers and program managers to bring focus to the development of commercially viable, environmentally friendly, small (10-50 MW), coal-based distributed energy systems. One of the objectives of this report is identifying the most likely and least resistant path to the commercialization of small-scale integrated gasification systems while meeting environmental constraints. This objective is based on the premise that development of a commercially acceptable product would lead to evolutionary product improvements over time as commercialization of the gas turbine and other energy products have proven. Another objective is to identify R&D efforts that could lead to “leap frog” advancements in the commercialization of small scale, coal-based integrated gasification systems.

The remainder of this report is divided into five (5) additional sections. Section 3 reviews coal and biomass gasification state-of-the-art and performance benchmarks. Section 4 screens gasification technologies that are best suited for small-scale applications. Section 5 discusses different coal gasification power and heat generation systems and their potential application as distributed energy systems. Section 6 concludes by summarizing the report findings. Finally, Section 7 provides a list of recommended action items for further considerations by program decision makers.

3. Gasification State-Of-Art And Performance Benchmarks

Before proceeding to a discussion of gasification status and benchmark, an overview of gasification technology is presented. This overview covers basic and fundamental technical issues that could impact future decisions. Understanding the relationship between gasifier conditions, product gas (syngas) and end-use applications is essential to determine the suitability or viability of small gasifiers for applications in distributed power generation market.

3.1 Overview of Gasification Technologies

Coal gasification is a process that converts coal from a solid to a combustible or synthesis gas (i.e., H₂, CO, CO₂, CH₄). In general, gasification is defined as the reaction of carbon with air, oxygen, steam, carbon dioxide or a mixture of these gases at 1,300°F or higher to produce a gaseous product that can be used to provide electric power and heat or as a raw material for the synthesis of chemicals, liquid fuels, or other gaseous fuels such as hydrogen. Once a carbonaceous solid or liquid fuel is converted to gaseous state, undesirable substances such as sulfur compounds and ash may be removed from the gas. In contrast to combustion processes, which work with excess air, most gasification processes operate at substoichiometric conditions with the oxygen supply controlled (generally 20% to 35% of the amount of O₂ theoretically required for complete combustion) such that both heat and a new gaseous fuel are produced as the solid fuel is consumed. Some gasification processes are heated indirectly to increase the gasification reactor temperature to a desired temperature and maintain it. These processes use steam as reactants. When a solid fuel is heated, directly or indirectly, under gasification conditions, it is first pyrolyzed. During pyrolysis light volatile hydrocarbons, rich in hydrogen, are evolved and tars, phenols and hydrocarbon gases are released. Depending on the gasification process, overlapping with or following the pyrolysis, the resulting char reacts with gaseous reactants (oxygen, steam, carbon dioxide, hydrogen) to release gases, tar vapors and a solid residue (char and ash). Reactions that take place in a gasifier may include:

- (1) $C + O_2 \rightarrow CO_2$
- (2) $C + \frac{1}{2}O_2 \rightarrow CO$
- (3) $H_2 + \frac{1}{2}O_2 \rightarrow H_2O$
- (4) $C + H_2O \rightarrow CO + H_2$
- (5) $C + 2H_2O \rightarrow CO_2 + 2H_2$
- (6) $C + CO_2 \rightarrow 2CO$
- (7) $C + 2H_2 \rightarrow CH_4$
- (8) $CO + H_2O \rightarrow H_2 + CO_2$

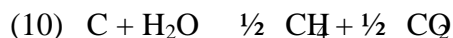
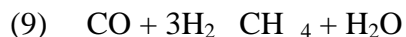

Most of the oxygen injected into a gasifier, either as pure oxygen or air, is consumed in reactions (1) through (3) to provide the heat necessary to dry the solid fuel, break up chemical bonds and raise the reactor temperature to drive gasification reactions (4) through (9).

Reactions (4) and (5), the principal gasification reactions, are endothermic and favor high temperatures and low pressures.

Reaction (6), the *Boudourd reaction*, is endothermic and is much slower than the combustion reaction (1) at the same temperature in the absence of a catalyst.

Reaction (7), hydrogasification, is very slow except at high pressures.

Reaction (8), the *water-gas shift reaction*, can be important if H₂ production is desired. Optimum yield is obtained at low temperatures (up to 500°F) in the presence of a catalyst and pressure has no effect on increasing hydrogen yield.

Reaction (9), the *methanation reaction*, proceeds very slowly at low temperatures in the absence of catalysts.

Reaction (10) is relatively thermal neutral, suggesting that gasification could proceed with little heat input but methane formation is slow relative to reactions (4) and (5) unless catalyzed.

In addition to the gasification agent (air, oxygen, and/or steam) and the gasifier operating temperature and pressure, several other factors affect the chemical composition, heating value, and the end use applications of the gasifier product gas. When considering coal gasification, these factors include:

- coal composition and rank
- coal preparation and particle size
- heating rate
- coal and gas residence time
- plant configuration such as:
 - coal feeding system -- dry or slurry
 - coal-reactant flow geometry
 - mineral removal system -- dry ash or slag

- heat generation and transfer method
- syngas cleanup system -- low or high temperature and processes used to remove sulfur, nitrogen, particulates, and other compounds that may impact the suitability of the syngas for specific applications (i.e., turbine and fuel cell for electric power generation, hydrogen production, liquid fuel production, or chemical production).

Depending on the gasifier system configuration, operating conditions, and gasification agent, three types of syngas can be produced:^{3,4,5}

- Low heating value gas (3.8 - 7.6 MJ/m³ or 100 - 200 Btu/ft³) -- It can be used as gas turbine fuel in an IGCC system, boiler fuel for steam production, and as fuel for smelting and iron ore reduction applications. However, because of its high nitrogen content and low heating value, it is not well suited as a natural gas replacement or for chemical synthesis.^{6,7} Use of low heating value gas for fuel cell applications also increases syngas processing costs, including compression costs if high pressure fuel cells are used.
- Medium heating value gas (10.5 - 16 MJ/m³ or 280 - 425 Btu/ft³) -- It can be used as fuel gas for gas turbines in IGCC applications, as a replacement for natural gas, for hydrogen production, for fuel cell feed, and for chemical synthesis.
- High heating value gas (over 21 MJ/m³ or 560 Btu/ft³) -- It can be used as substitute for natural gas.

3.2 Coal Gasification Technology

A large number of coal gasification processes exist that are already commercialized or are ready to be commercialized. These technologies are presented in Figure 3.1 and are detailed in Appendix I. New gasification technologies are also being developed with the promise of improved environmental performance, system efficiency, and/or costs.^{8,9,10,11}

Gasifiers can generally be grouped into three classes depending on their flow geometry.

³ Gasifiers in Industry Program

⁴ Handbook of Gasifiers and Treatment Systems, 1982

⁵ Coal Gasification: Direct Applications and Syntheses of Chemicals and Fuels, 1987

⁶ Technical Papers of Gasification Technologies Conference 1998 - 2002

⁷ Evaluation of Coal-Gasification Technology, Part 1 - Pipeline Quality Gas and Part II -Low and Intermediate Btu Fuel Gases, Office of Coal Research, Department of Interior.

⁸ Marsulex, Inc. confidential report on MTCI Pulsed Gasification Technology, by Stone & Webster, Inc. May 2002.

⁹ Confidential communications, N-TEK, LLC. September 2002.

¹⁰ Confidential communications, Hamilton Mauer International, Inc.

¹¹ R&D on Micro-gasifiers for Efficient Thermal Utilization of Solid Fuels, IJPG2000-15076, Proceedings of 2000 International Joint Power Generation Conference, Miami Beach, Florida, July 2000.

Figure 3.1 Coal Gasification Technologies And Classifications

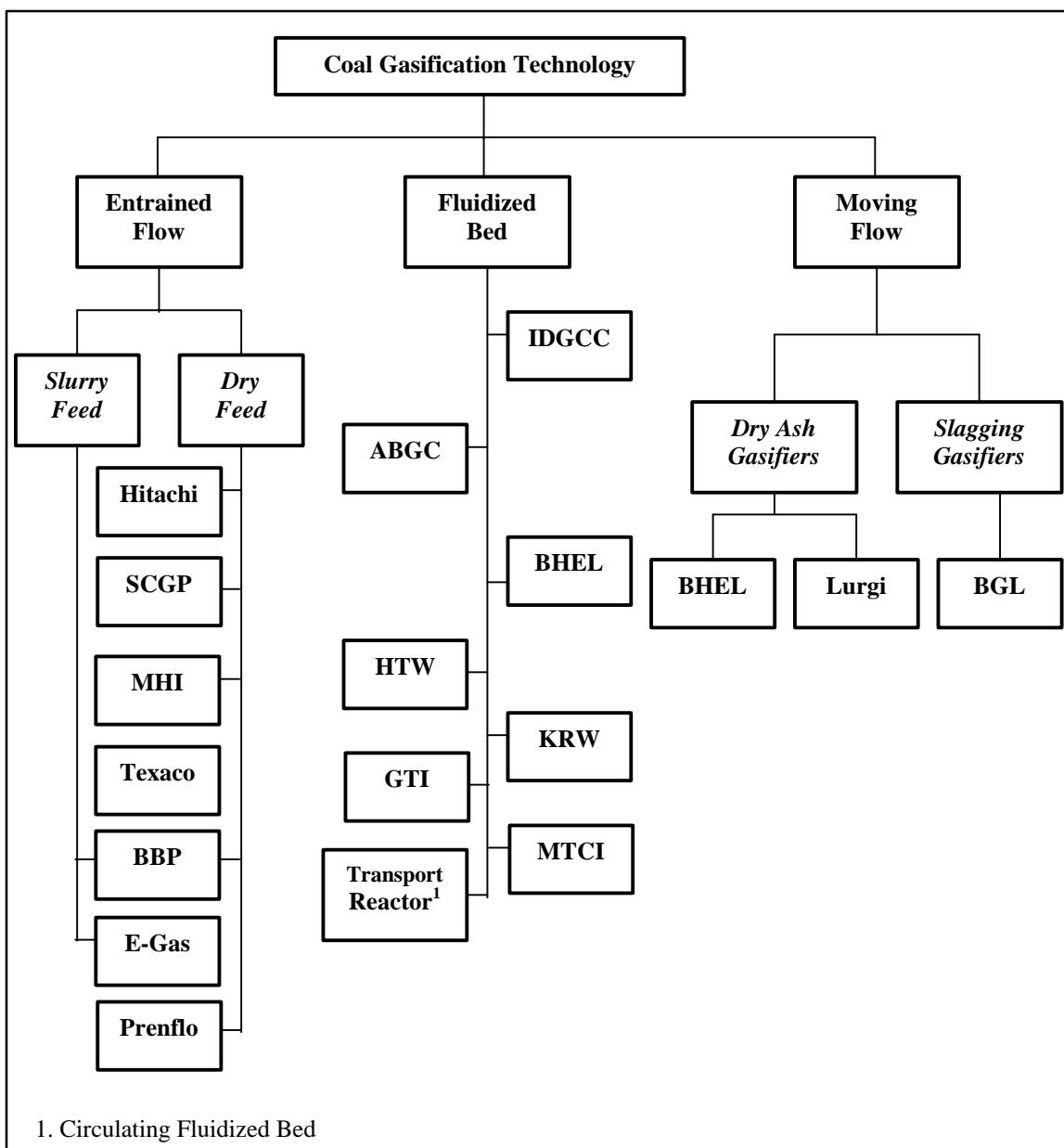

They are:

- Entrained-flow gasifiers
- Fluidized-bed gasifiers
- Fixed or moving bed gasifiers.

They can further be classified as air or oxygen blown depending on the oxidant agent used. A variation of fluidized bed gasification, known as steam reforming, uses an indirect heating method rather than directly combusting some of the fuel in the gasification reactor. It also uses steam to fluidize the bed of solids rather than a mix of steam and air or oxygen that is used in most other fluidized bed gasifiers. Table 3.1 summarizes the characteristics of currently available gasification technologies. Other gasifiers, based on other technologies such as rotary kilns and molten baths, were also developed in the early to mid 1900's but were not commercialized and are not considered in this report, although some interest in the further development of molten bath technology has been shown recently by some technology developers.

Table 3.1 - Typical Characteristics Of Coal Gasifiers

	Entrained-flow	Fluidized-bed	Fixed-bed
Coal Feed System	Dry/Slurry	Dry	Dry
Coal Feed Particle Size, mm	< 1	0.5 - 6	5 - 80
Residence Time, Sec.	<5	10 -100	900 - 1800 at high pressure
Gasifier Temperature, °F	1800 - 3500	1400 -2000	2400 - 3200 at combustion zone 700 - 950 at pyrolysis zone
Gasifier Pressure, Atm	20 - 80	1 - 30	1 - 100
Reactants	Oxygen/Steam	Air/Steam, Oxygen/Steam, or Steam	Oxygen/Steam or Air/steam
Ash Removal	Dry/Slagging	Dry/Agglomerating	Dry/Slagging
Heating Value	Medium/High	Low/Medium	Low/Medium

As noted above, coal can be used to produce hydrogen and liquid fuels. The co-production of electricity and hydrogen from coal using integrated gasification combined cycle technology has the potential to produce hydrogen at the \$3 – \$5/MBtu range.² When coupled with carbon sequestration, the hydrogen can be produced with near-zero emissions. Co-production of liquid fuels and electricity has the potential of reducing coal-liquid fuel costs from the current estimated cost of \$30 per barrel to \$20 - \$25 per barrel.² However, the construction of coal liquid fuel plants is capital cost intensive, requiring a capital investment of \$30,000 - \$50,000 per barrel per day of plant capacity.²

3.2.1 Entrained-flow Gasifiers

Today, entrained-flow gasifiers are the most versatile and widely used large-scale gasifiers for power generation in the world. Different gasification projects based on this

type of gasifier are either in operation or under construction. Entrained-flow gasifiers are all oxygen blown, slagging gasifiers producing medium heating value syngas. Thus, they can be used to produce syngas for power generation applications in IGCC plants and in fuel cells, hydrogen production, and/or chemical synthesis. Coal can be fed either as dry or as slurry into the gasifier. However, the gasifier's short residence time (seconds) requires coal to be pulverized to less than one millimeter. Entrained-flow gasifiers operate at high temperatures, 1,800°F -3,500°F, and pressures, 300 psi-1180 psi. Their high temperature, above the ash slagging temperature, ensures high carbon conversion and produces medium heating value syngas that is free from phenols and tars. The high temperature, however, negatively impacts burner and refractory life and increases operating costs due to replacement requirements. They also require high temperature heat exchangers constructed from exotic and expensive materials for cooling the syngas. Entrained-flow gasifiers are not recommended for high ash coals and coals with high fusion temperatures.

Entrained-flow gasifiers are not considered economical in small scales due to their high capital costs, which are primarily due to the requirement for an oxygen unit and heat exchangers requiring exotic materials.

3.2.2 Fluidized-Bed Gasifiers

Fluidized-bed gasifiers are typically air or oxygen blown, bubbling or circulating bed, and operate with crushed (0.5 - 5 millimeter) fuels. Coal particles are introduced into an upward flow of gas that fluidizes the bed of fuel and provides reactants for gasifying the coal particles. The bed is usually formed from sand, char, sorbent, and ash. The residence time of the coal particles is typically in the order of 10 to 100 seconds. Fluidized bed gasifiers operate at lower temperatures than entrained-flow gasifiers do, and well below the ash fusion temperatures to avoid ash melting. They generally operate at 1,400°F – 2,000°F and 15 psi – 450 psi. Air-blown gasifiers produce low heating value gas and oxygen-blown gasifiers produce medium heating value gas. Some atmospheric fluidized bed gasifiers, known as steam reformers (MTCI and FERCO processes), are indirectly heated and thus steam is used as the primary fluidizing gas. These gasifiers produce a hydrogen rich, medium heating value gas without requiring an oxygen unit.

A disadvantage of fluidized-bed gasifiers, compared to entrained-flow gasifiers, is their lower rate of carbon conversion in a single stage due to their lower temperature. To improve carbon conversion, char is either recirculated into the gasifier or is burned in a separate combustion unit (hybrid cycle). However, because they operate at lower temperatures than entrained-flow gasifiers, fluidized-bed gasifiers do not require expensive high temperature gas cooling systems.

Fluidized-bed gasifiers may also differ in their ash discharge methods, using dry or agglomerated ash removal systems. Dry ash removal systems offer high system turndown flexibility while agglomerated ash operation improves the ability to gasify high rank coals more efficiently.

A few fluidized-bed gasifiers operated commercially in the 1980s and 1990s for the synthesis of chemicals and for demonstrating their applications for power generation in IGCC plants. Foster Wheeler, under DOE's sponsorship, is developing a fluidized-bed partial gasification process that has the potential to be less expensive than the current generation of IGCC systems. New fluidized-bed plants, for power generation, based on HTW technology, are also under construction in the Czech Republic. Small-scale plants based on GTI's technology, known as U-Gas, are operating in China and produce syngas as feedstock for chemical production. Other small-scale plants, based on steam reforming technology, are also under construction or are being operated in the U.S. and Canada. However, these plants use biomass or black liquor as fuel. Biomass gasification processes are further discussed in Section 3.3.

3.2.3 Fixed-bed Gasifiers

Although fixed-bed gasifiers are currently not as popular as entrained-flow gasifiers for power generation applications, these types of gasifiers are based on mature technologies developed in the 1800s and early 1900s. They are less capital intensive and operationally more forgiving than other gasification technologies; they also have longer residence time.

Many of the fixed-bed gasifiers developed in the early 1900s were small in scale, processing less than 100 tons per day of coal, and used air and steam as reactants. During the oil shortages of the mid to late 1970s, the U.S. government initiated the "Gasifiers in Industry Program" to encourage industry to build small gasifiers, based on proven technologies, to generate low heating value gas as a replacement for natural gas in their processes. Gasification technologies that were proven in industrial operations and were further demonstrated under the "Gasifiers in Industry Program" included the Wellman-Galusha single-stage gasifier, the Woodal-Duckman two-stage gasifier, the Wellman-Incandescent two-stage gasifier, and the STOIC two-stage gasifier. Most existing fixed-bed gasification technologies are a variation or an improved version of these earlier technologies. While these earlier gasifiers were air blown, today's fixed-bed gasifiers are mostly oxygen blown.

Fixed-bed gasifiers require lump (5 - 80 millimeter) sized coal and processing may be needed to remove very fine coal particles before the coal is fed into the top of the gasifier via lock hopper systems. A mixture of oxygen and steam introduced at the bottom of the gasifier runs counter flow to the coal. Coal residence time in fixed-bed gasifiers is 15 - 30 minutes for high pressure, oxygen blown gasifiers and can be several hours for atmospheric pressure, air blown gasifiers.

Coal entering the top of the gasifier is sequentially preheated, dried, pyrolyzed, gasified, and combusted while moving toward the bottom of the reactor. Finally, the resulting char is completely burned at the bottom of the reactor, the combustion zone, where the bed reaches its highest temperature. The temperature of the combustion zone is generally in the 2,700°F-3,300°F range for slagging gasifiers and about 2,400°F for dry bottom gasifiers while the temperature of gas leaving the gasifier is in 700°F-950°F range. Because of the low temperature at the top of the gasifier, the product gas includes tars,

phenols, oils, and low boiling point hydrocarbons produced in the gasifier's pyrolysis zone. Recent designs incorporate a recycle loop that returns these by-products to the gasifier for further reactions. Existing coal gasification technologies based on the fixed-bed gasification process are shown in Figure 3.1 and detailed in Appendix I.

3.3 Biomass Gasification Technology

Biomass-based technologies have been surveyed as a part of this assessment to determine their applicability to coal. Because biomass gasification technologies are being developed to serve the distributed generation market, a review of these technologies could help identify the type of small-scale gasifiers that could be more economical than the coal gasifiers that have been primarily developed for large central utility applications. Co-gasification of coal and biomass, a relatively new area of research and development, has also shown promising results in terms of the quality of the syngas and reduced environmental impact.

Biomass has lower energy content than coal; however, its use for energy production can significantly contribute to the reduction of net CO₂ emissions. These two fuels, when co-gasified, exhibit synergy with respect to overall emissions, including greenhouse gas emissions, without sacrificing the energy content of the product gas. Biomass, whether as a dedicated crop or a waste-derived material, is renewable. However, the availability of a continuous biomass supply can be problematic. For example, crop supply may be decreased by poor weather or by alternative uses, and the availability of a waste material can fluctuate depending on variations in people's behavior. With co-gasification, adjusting the amount of coal fed to the gasifier can alleviate biomass feedstock availability fluctuations. This approach may also allow biomass feedstocks to benefit from the same economies of scale as achieved with coal gasification that may be necessary for the economic production of fuels, chemicals and hydrogen.

A recent report¹² surveying the existing biomass gasification technologies identified over 25 biomass gasification technologies (Figure 3.2). These technologies can be classified into two groups: moving- or fixed-bed and fluidized-bed technologies. Fixed-bed gasifiers can be divided into downdraft and updraft gasifiers. Fluidized-bed gasifiers are also divided into two classes: bubbling and circulating. Fluidized-bed gasifiers can also be divided into directly or indirectly heated gasifiers.

Directly heated bubbling fluidized-bed gasifiers are the most widely demonstrated biomass gasifiers. These types of gasifiers have been demonstrated at pressures of up to 300 psi and temperatures of up to 1,800°F using air and oxygen as oxidants.

Circulating fluidized-bed gasifiers for biomass applications have not been demonstrated to the same extent as the bubbling fluidized bed, have not used pure oxygen as oxidant, and have not operated at the high pressures which are preferred for production of fuels for power generation and chemical synthesis.

¹² Ciferno, Jared, P. and Marano, John, J., *Benchmarking Biomass Gasification Technology for Fuels, Chemicals and Hydrogen Production*, NETL, June 2002

Fixed bed gasifiers tend to produce large quantities of tars, oils, and char. They have not been prime candidates for syngas production for power generation applications or chemical synthesis. Small-scale (less than 10 kW) units are, however, gaining popularity for microturbine applications. They offer low costs and are easy to operate.

Indirectly heated gasification technology is demonstrated at atmospheric pressures. They require a separate combustion unit but the syngas is not diluted with nitrogen and has a higher value than directly heated air blown gasifiers. As with other atmospheric pressure technologies, they will require syngas compression for gas turbine applications, hydrogen production, or chemical synthesis. Data from a demonstration unit based on FERCO technology operating at the McNeil Station should become available shortly.

Commercial scale units based on MTCI technology are under construction in the U.S. and Canada for black liquor recovery. MTCI technology was also demonstrated on coal as part of the Clean Coal Technology (CCT) program.

3.3.1 Updraft Gasifiers

Also known as counter flow gasification, the updraft fixed-bed configuration is the oldest and simplest form of gasifier and, as indicated earlier, is still used for coal gasification. Biomass is introduced at the top of the reactor and a grate at the bottom of the reactor supports the reacting bed. Usually air and/or steam are introduced below the grate and are diffused up through the bed of biomass and char. Complete combustion of char takes place at the bottom of the bed, liberating CO₂ and H₂O. These hot gases (1,800°F) pass through the bed above, where they are reduced to H₂ and CO and are cooled to about 1,350°F. Continuing up the reactor, the reducing gases (H₂ and CO) pyrolyze the descending dry biomass and finally dry the incoming wet biomass, leaving the reactor at a low temperature (<900°F). Examples are the PUROX and the Sofresid/Caliqua technologies.

3.3.2 Downdraft Gasifiers

Also known as cocurrent-flow gasification, downdraft gasifiers have the same mechanical configuration as the updraft gasifiers except that the oxidant and product gases flow down the reactor, in the same direction as the biomass. A major difference is that this process can combust up to 99.9% of the tars formed. Low moisture biomass (<20%) and air or oxygen are ignited in the reaction zone at the top of the reactor. The flame generates a pyrolysis gas/vapor, which burns intensely leaving 5% to 15% char. The gases flow downward and react with the char at 1,470°F to 2,200°F, generating more CO and H₂ while being cooled to below 1,470°F. Finally, unconverted char and ash pass through the bottom of the grate and are sent to disposal.

3.3.3 Bubbling Fluidized-Bed Gasifiers

Most biomass processes under development employ bubbling fluidized-bed gasifiers. A bubbling fluidized bed consists of fine, inert particles of sand or alumina, which have

Figure 3.2 – Biomass Gasification Technologies And Classifications¹

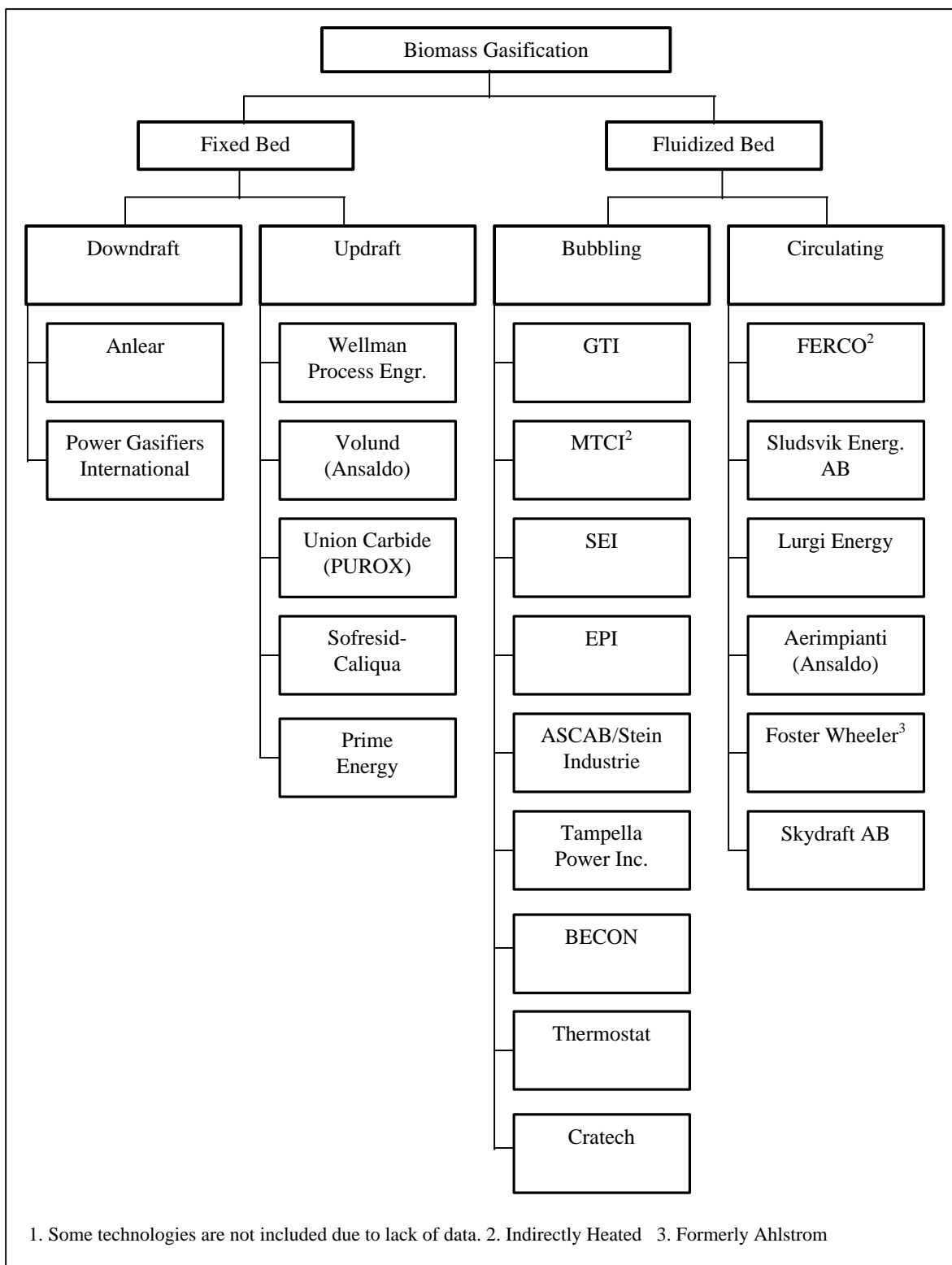

been selected for size, density, and thermal characteristics. As gas (generally air or steam) is forced through the inert particles, a point is reached when the frictional force between the expanded bed particles and the gas counterbalances the weight of the solids. At this gas velocity (minimum fluidization), bubbling of gas through the media occurs, such that the particles remain in the reactor and appear to be in a "boiling state". The fluidized particles tend to break up the biomass fed to the bed and ensure good heat transfer throughout the reactor.

3.3.4 Circulating Fluidized-Bed Gasifiers

Circulating fluidized-bed gasifiers operate at gas velocities higher than the minimum fluidization point, resulting in the entrainment of the particles in the gas stream. The entrained particles in the gas exiting the top of the reactor are separated in a cyclone and are returned to the reactor.

3.4 Syngas Cooling and Cleaning Systems

The composition and quality of syngas depends on several factors including the feedstock (i.e, coal type and rank or biomass composition), gasifier type, and processing conditions (temperature, pressure, oxidant, heating rate, etc.). Depending on the end-use application (i.e., boiler/steam, combustion engine, fuel cell, chemical synthesis, etc.) syngas must also be cooled and cleaned.

Cooling is carried out by either using high temperature syngas coolers or by quenching the gas with water. The typical steps for a gas clean-up system are aimed at particulate, sulfur, ammonia, and chlorides removal. This is achieved as follows:

- Particulate Removal: Combination of cyclone filters and ceramic candle filters
- Acid gas (H₂S, CO₂, NH₃) removal: Combination of steam/water washing and removing the sulfur compounds for recovery of sulfur as a salable product.

In addition, certain compounds such as H₂S and HCl must be removed because of the detrimental effect they can have on downstream processes or equipment.

Sulfur in the fuel is captured by reducing it to H₂S, COS, CS₂ etc. The current high temperature sulfur removal systems employ zinc-based regenerative sorbents (zinc ferrite, zinc titanate etc.). Such zinc-based sorbents have been demonstrated at temperatures up to 1,200°F. Sulfur is also removed by the addition of limestone in the gasifier. This approach is commonly adopted in air-blown fluidized-bed gasifiers. In the case of air-blown gasifiers, sulfur is captured in the gasifier (above 90%) because of addition of limestone to the fluidizing bed. The sulfur captured in the bed is removed with char.

Hot gas clean-up technology is currently in the demonstration phase and it has not been successful so far. Wet scrubbing technology, though with a lower efficiency, still remains the preferred option for gas clean-up systems in IGCC applications.

4. Syngas Applications And Technology Selection Criteria

The overall objective of this study is to identify technology gaps and R&D needs for coal gasification power systems in the 10-50 MW range. In order to accomplish this, it is first necessary to understand where each gasification technology is best suited in terms of end-use applications. This screening or matching of technologies to end-use applications provides an understanding of what is possible based on current technology applications, and further enables identification of what R&D needs are necessary for commercialization.

Table 4.1 compares the desirable syngas characteristics for different end-use applications based on the current status of technologies for different end-use applications. For purposes of completeness, Table 4.1 includes the desirable syngas characteristics not only for power generation, but also for synthetic fuels production. However, no further discussions or analysis has been performed on these product forms. Synthetic fuels derived from coal gasification technologies would require a separate study in order to assess potential technology gaps needed for the commercialization of these fuels.

Table 4.2 presents different gasification technologies and the characteristics of the syngas produced by these technologies. Table 4.3 presents operating parameters and the current status including feedstock used and demonstration and/or commercial plant sizes. The desired characteristics from Table 4.1 for fuel cell and gas turbine applications are compared and matched to those syngas characteristics found in Table 4.2 to identify gasification technologies that could potentially be used for power generation applications.

Unfortunately, this is not a straightforward and simple task because of the wide variation in feedstock compositions used by developers, different process conditions, and lack of sufficient data. Syngas composition varies based on many factors, including reactor type, feedstock, and processing conditions (e.g., temperature, pressure, type of reactant, etc.). In turn, specific end-use product applications depend on the intermediate products of the syngas and the limitations of technologies for syngas conversion to fuels. Despite these shortcomings, comparisons are possible, especially when we recognize that biomass gasification technologies in general produce a lower quality syngas when compared to coal gasification under similar operating conditions. We assume for the purposes of this analysis that the heating values and compositions reported in Table 4.2 for gasification technologies developed exclusively from biomass feedstocks are conservative, and emphasis is only given to those biomass-based technologies that are comparable to the leading coal-based technologies.

Figure 4.1 provides a logic diagram devised for the purposes of screening gasification technologies as to their suitability to specific end-use applications. In assessing the technology matches to applications, individual gasification technologies are referenced to the respective number designations assigned to each in Table 4.2 and 4.3. Figure 4.1 represents the initial screening evaluation. The discussions below expand on this flow chart for the small-scale power generation applications.

Table 4.1. Desirable Syngas Characteristics For Different End-Use Applications Based On Current Technology Limitations

Product	Synthetic Fuels	Methanol	Hydrogen	Fuel Gas					
	FT Gasoline and Diesel			Boiler	Turbine	Fuel Cell			
						PAFC	MCFC	SOFC	PEFC
H ₂ /CO	0.6 ^a	~2.0	High	Unimportant	Unimportant	H ₂ is fuel ⁿ but CO is a poison > 0.5%	Both H ₂ and CO are fuels, with H ₂ preferred ^l	H ₂ and CO are fuels	H ₂ is fuel but CO is a poison > 10 ppm.
CO ₂	Low	Low ^c	Not important ^b	Not critical	Not critical	Diluent	Diluent	Diluent	Diluent
Hydrocarbons	Low ^d	Low ^d	Low ^d	High	High	CH ₄ is diluent	CH ₄ is diluent ^m	CH ₄ is fuel ^o	CH ₄ is diluent
N ₂	Low	Low	Low	Note ^e	Note ^e				
H ₂ O	Low	Low	High ^f	Low	Note ^g	Diluent	Diluent	Diluent	Diluent
Contaminants	<1ppm Sulfur and Low Particulates	<1ppm Sulfur and Low Particulates	<1ppm Sulfur and Low Particulates	Note ^k	Low Particulates and Low Metals	S as H ₂ S and COS is a poison > 50 ppm	S as H ₂ S and COS is a poison > 0.5 ppm	S as H ₂ S and COS is a poison > 1.0 ppm	No studies to date
Heating Value	Unimportant ^h	Unimportant ^h	Unimportant ^h	High ⁱ	High ⁱ	Unimportant	Unimportant	Unimportant	Unimportant
Pressure, bar	~20-30	~50 (liquid phase) and ~140 (vapor phase)	~28	Low	~400	Up to 8	High	14.8-30	High
Temperature, °C	200-300 ^j ; 300-400	100-200	100-200	250	500-600	100-200	650	1000	80

Source: Ciferno, Jared, P. and Marano, John, J., Benchmarking Biomass Gasification Technology for Fuels, Chemicals and Hydrogen Production, NETL, June 2002

Notes:

- Depends on catalysts type. For iron catalyst, value shown is acceptable; for cobalt catalyst, a value closer to 2.0 is recommended.
- Water gas shift is needed to convert CO to H₂; CO₂ in syngas can be removed at same time as CO by the water in the gas shift reaction.
- Some CO₂ can be tolerated if the H₂/CO ratio > 2.0 (as can occur with steam reforming of natural gas); if excess H₂ is available, the CO₂ will be converted to methanol.
- Methane and heavier hydrocarbons must be recycled for conversion to syngas and represent system inefficiency.
- N₂ lowers the heating value, however the level is unimportant provided the syngas can be burned with a suitable flame.
- Water is required for the water gas shift reaction.
- Capable of tolerating high water levels; steam is sometimes added to moderate combustion temperature for NO_x control purposes.
- As long as H₂/CO and impurities levels are met, heating value is not critical.

- (i) Efficiency improves as heating value increases.
- (j) Depends on the catalyst type; iron catalysts typically operate at higher temperatures than cobalt catalysts.
- (k) Small amounts of contaminants can be tolerated.
- (l) In reality, CO with H₂O shifts H₂ and CO₂, and CH₄ with H₂O reforms to H₂ and CO faster than reaction as a fuel at the electrode. CO is a poison for lower temperature fuel cells, but is used as a fuel in the high temperature cells (e.g., SOFC, MCFC). CO may not actually react electrochemically within these cells. It is commonly understood that CO is consumed in the gas phase through the water-gas shift reaction as $\text{CO} + \text{H}_2\text{O} = \text{CO}_2 + \text{H}_2$. The H₂ formed in this reaction is subsequently consumed electrochemically.
- (m) CH₄ is a fuel in the internal reforming stage of MCFC.
- (n) H₂ is the optimal fuel for all types of fuel cells.
- (o) CH₄ can be oxidized directly using a solid oxide fuel cell, however high concentrations of CH₄ lead to severe coking problems. Only cells containing dilute concentrations of CH₄ can be oxidized directly in current SOFCs. In addition, the oxidation of CH₄, like that of CO, may not actually occur at active electrochemical sites within an SOFC. Rather, CH₄ is probably reformed within the cell through steam reforming.

Table 4.2 – Syngas Product Characteristics by Gasification Technology And Fuel Type

Reference No, Developer/ Process Name	Reactor Type	Heating Value		Syngas Composition (Mole.%)									
		MJ/m ³	Btu/ft ³	H ₂	CO	CO ₂	CH ₄	C ₂ ⁺	H ₂ S	H ₂ O	N ₂	Other	CO/H ₂
COAL GASIFICATION TECHNOLOGIES													
Typical, Dry Feed	Entrained Flow	4 - 10	112-300	10-35	30-65	1-12	<3						
Typical, Slurry Feed	Entrained Flow	10 -12	260 -321	34-40	37-52	12-20	<2						
1. Hitachi EAGLE	Entrained Flow	10.46	280										
2. Shell Coal Gasification Process (SCGP)	Entrained Flow	8.235	221	24-34.4	35 - 67	1-5	<0.3			3	<1		<2.8
3. Mitsubishi Heavy Industries (MHI)	Entrained Flow	4.187	112										
4. Texaco	Entrained Flow	10-12	268-321	35-39	37-52	12-20	0.5		1.5		0.6		<1.4
5. Babcock Borsig Power (Noell)	Entrained Flow												
6. E-Gas (Destec)	Entrained Flow	10.34	277	34.4	45.3	15.8	1.9				1.9		1.3
7. Prenflo	Entrained Flow	est. <10	est. < 268										
Typical	Bubbling Fluidized Bed	<14	<400	15-35	19-51	7-25	<2						
8. Integrated Drying Gasification Combined	Bubbling Fluidized Bed									Hi			

Table 4.2 – Syngas Product Characteristics by Gasification Technology And Fuel Type (Continued)

Reference No, Developer/ Process Name	Reactor Type	Heating Value		Syngas Composition (Mole.%)										
		MJ/m ³	Btu/ft ³	H ₂	CO	CO ₂	CH ₄	C ₂ ⁺	H ₂ S	H ₂ O	N ₂	Other	CO/H ₂	
Cycle (IDGCC)														
9. Air Blown Gasification Cycle (ABGC)	Bubbling Fluidized Bed	3.6	96											
10. BHEL (Indian Institute of Tech.)	Bubbling Fluidized Bed													
11. High Temperature Winkler (HTW)	Bubbling Fluidized Bed		370	35.3	51.9	8.9	3.2		0.08					1.47
12. Kellog Rust Westinghouse (KRW)	Bubbling Fluidized Bed	5	133	15	19	9	3				54			
13. Transport Reactor Gasifier	Circulating Fluidized Bed	4	107											
Typical	Fixed Bed	2.6–13.7	70-370	4.4-40	11.6-61	3-30	3-9							
14. BHEL pilot plant	Fixed Bed	6-13.8	160-370	15-40	18-61	3-30	3-9							
15. Lurgi dry ash process	Fixed Bed													
16. Schwarze Pumpe complex (Germany)	Fixed Bed													
17. British Gas/Lurgi (BGL)	Fixed Bed													
BIOMASS GASIFICATION TECHNOLOGIES														
18. Wellman Process Engr.	Fixed Bed	5.53	148	6.9	29.5	6.1		22.2			35			

Table 4.2 – Syngas Product Characteristics by Gasification Technology And Fuel Type (Continued)

Reference No, Developer/ Process Name	Reactor Type	Heating Value		Syngas Composition (Mole.%)									
		MJ/m ³	Btu/ft ³	H ₂	CO	CO ₂	CH ₄	C ₂ ⁺	H ₂ S	H ₂ O	N ₂	Other	CO/H ₂
19. Volund (Ansaldo)	Fixed Bed	2.6-5.0	70-134	4.4	11.6	14.7	4				64		
20. Union Carbide Purox Process	Fixed Bed	13.7	367	23.43	39.06	24.41	5.47	4.93	0.05			2.65	
21. Sofresid- Caliqua	Fixed Bed	Low											
22. Gas Techn. Inst.	Bubbling Fluidized Bed	12.97	350	25.3	16	39.4	17.8	1.5	-	-	0	-	
23. MTCI	Bubbling Fluidized Bed	16.24	438	43.3	9.22	28.1	4.73	9.03		5.57		0.08	
24. Citicorp Ind. Credit	Bubbling Fluidized Bed	6.9	186	12.67	15.5	15.88	5.72	2.27			48		
25. Energy Products of Idaho	Bubbling Fluidized Bed	5.6	150	5.8	17.5	15.8	4.65	2.58	0	0	52	0.8	
26. ASCAB/Stein Industrie	Bubbling Fluidized Bed	5.52	155	19.87	25.3	40	0	0			13		
27. Tampella Power Inc.	Bubbling Fluidized Bed	5	140	11.3	13.5	12.9	4.8			17.7	40		
28. BECON Iowa State	Bubbling Fluidized Bed	4.5	126	4.1	23.9	12.8	3.1				56	0.2	
29. BCL/FERCO	Circulating Fluidized Bed	18.7	500	14.9	46.5	14.6	17.8	6.2					

Table 4.2 – Syngas Product Characteristics by Gasification Technology And Fuel Type (Continued)

Reference No, Developer/ Process Name	Reactor Type	Heating Value		Syngas Composition (Mole.%)									
		MJ/m ³	Btu/ft ³	H ₂	CO	CO ₂	CH ₄	C ₂ ⁺	H ₂ S	H ₂ O	N ₂	Other	CO/H ₂
30. TPS- Thermal Process- Studsvik	Circulating Fluidized Bed	5.5	147	7-9	9-13	12-14	6-9	-	-	10-14	47-52	0.5-1.0	
31. Lurgi Energy	Circulating Fluidized Bed	5.8	155	20.2	19.6	13.5	3.8				43	0.1	
32. Aerimpianti	Circulating Fluidized Bed	5	134	7-9	9-13	12-14	6-9			10-14	47-52	0.5-1.0	
33. Foster Wheeler	Circulating Fluidized Bed	7.5	201	15-16	21-22	10-11	5-6				46-47		
34. Sydkraft AB	Circulating Fluidized Bed	5.8	121	9.5-12	16-19	14.4-17.5	5.8-7.5				48-52		

Table 4.3 – Key Operating Characteristics Of Gasification Technologies

Reference No, Developer/ Process Name	Reactor Type	Feedstock	Application	Feed Rate, tpd	Reactor		Reactant	Gas Exit Temperature, °C
					Pressure, psi	Temperature, °C		
1. Hitachi (EAGLE)	Entrained Flow	Coal	IGCC, IGFC, MCFC, Ultra-supercritical steam; 250 MWe and 1000 kW MCFC	150	360		Oxygen	450
2. Shell Coal Gasification Process (SCGP)	Entrained Flow	Coal (bituminous, hi moist./hi ash lignites)	IGCC, ammonia, urea, H ₂ , methanol; 400 MW under development	220, 365, and 2000	290-580	1500	Steam/O ₂	300
3. Mitsubishi Heavy Industries (MHI)	Entrained Flow	Coal (high ash m.p. Australian)	IGCC: units developed include 27, 125, 250 MW	200 and 1500	15		Oxygen	350-450
4. Texaco	Entrained Flow	Coal	IGCC, H ₂ , chemical synthesis; (430 MW and 523 MW plants),	2300	435 for Power, 870- 1160 for H ₂ , 1,015 for acetic acid and acetic anhydride	1200-1450	Steam/O ₂	700
5. Babcock Borsig Power (Noell)	Entrained Flow	Coal (anthracites and brown), Waste oil, Sludge	IGCC 5, 10 and 30 MW demonstration plants				Steam/O ₂	150-200
6. E-Gas (Destec)	Entrained Flow	Coal (bituminous, hi S, Ill. No. 6, Petcoke)	Production of steam, fuels/chemicals, and electricity, IGCC; 96 and 296 MW plants	2200	435	1350-1400		370

Table 4.3 – Key Operating Characteristics Of Gasification Technologies (Continued)

Reference No, Developer/ Process Name	Reactor Type	Feedstock	Application	Feed Rate, tpd	Reactor		Reactant	Gas Exit Temperature, °C
					Pressure, psi	Temperature, °C		
7. Prenflo	Entrained Flow	Coal-Petcoke (50/50)	IGCC; 338 MW	2600	363		Oxygen	380
8. Integrated Drying Gasification Combined Cycle (IDGCC)	Bubbling Fluidized Bed	Coal (hi moisture, low rank)	IGCC		363	900	Air	40
9. Air Blown Gasification Cycle (ABGC)	Bubbling Fluidized Bed	Coal	IGCC		363	900-1000		400
10. BHEL (Indian Institute of Tech.)	Bubbling Fluidized Bed	Coal (hi ash - 42%)	IGCC; 6.2 MW pilot plant	18, 150, 168	188	1000		
11. High Temperature Winkler (HTW)	Bubbling Fluidized Bed	Coal (lignites, hi volatile bituminous), coal/coke mix, peat	Methanol, ammonia, IGCC; 36 and 300 MW; 400 MW designed	140	145-435	800	Steam/O ₂ , air	
12. Kellog Rust Westinghouse (KRW)	Bubbling Fluidized Bed	Coal	IGCC; 100 MW plant		290	900	Air/Steam	600
13. Transport Reactor Gasifier	Circulating Fluidized Bed	Coal (sub- bituminous), KY and IL No. 6, coke breeze	IGCC	26.8-64		870-1000	O ₂ , Air	
14. BHEL pilot plant	Fixed Bed	Coal	IGCC (plant sizes developed between 6 and 150+ MW)	24.0, 150	145		Air/Steam	

Table 4.3 – Key Operating Characteristics Of Gasification Technologies (Continued)

Reference No, Developer/ Process Name	Reactor Type	Feedstock	Application	Feed Rate, tpd	Reactor		Reactant	Gas Exit Temperature, °C
					Pressure, psi	Temperature, °C		
15. Lurgi dry ash process	Fixed Bed	Coal	Fuels, Chemicals, ammonia (several plants 100 MW plus 361 MW)	363-406	980-1040		Steam/O ₂	300-500
16. Schwarze Pumpe complex (Germany)	Fixed Bed	Coal	Electricity (85 MW), methanol					
17. British Gas/Lurgi (BGL)	Fixed Bed	Coal	IGCC		2000		CO ₂ , O ₂ , Steam	450-500
18. Wellman Process Engineering .	Fixed Bed	Wood	Engine	10	NA	600-1000	Air/Steam	100
19. Volund (Ansaldo)	Fixed Bed	Straw	Heat	13	atm.		Air/Steam	250
20. Union Carbide (Purox Process)	Fixed Bed	MSW	IGCC	200		750-1100	Oxygen	180-300
21. Sofresid-Caliqua	Fixed Bed	MSW	Steam for district heating and electricity	215	14.5	1300-1400	Hot air	
22. Gas Technology Institute (GTI)	Bubbling Fluidized Bed	Woody biomass	Fuel gas, syngas	3.6-12	479	816	Oxygen/Steam	816
23. MTCI	Bubbling Fluidized Bed	Pulp, Paper mill sludge, black liqueur, Coal	Steam	200	15	790-815	Steam	

Table 4.3 – Key Operating Characteristics Of Gasification Technologies (Continued)

Reference No, Developer/ Process Name	Reactor Type	Feedstock	Application	Feed Rate, tpd	Reactor		Reactant	Gas Exit Temperature, °C
					Pressure, psi	Temperature, °C		
24. Alternate Gas (Citicorp Ind. Credit)	Bubbling Fluidized Bed	Wood Chips	Lime kiln, Boiler and drier fuel	200	14.7	649-815	Hot Air	745-801
25. Energy Products of Idaho (formerly JWP Energy Products)	Bubbling Fluidized Bed	Wood Chips	Steam for power production	110	14.7	650	Air	621
26. ASCAB/Stein Industrie	Bubbling Fluidized Bed	Wood Chips	Methanol production, Electricity (<i>Process has been abandoned</i>)	50	220.5	716	Steam/O ₂	
27. Tampella Power Inc.	Bubbling Fluidized Bed	Biomass, Coal	Fuel for gas turbines, Boiler fuel	40	290-334	850-950	Air	300-350
28. BECON (Biomass Energy Conservation Facility)	Bubbling Fluidized Bed	Shelled Corn	IGCC	5	14.7	730	Air	
29. BCL/FERCO	Circulating Fluidized Bed	Wood	Fuel gas (200 considered min. acceptable size)	26-200	15	600-1000	Air/Steam	820

Table 4.3 – Key Operating Characteristics Of Gasification Technologies (Continued)

Reference No, Developer/ Process Name	Reactor Type	Feedstock	Application	Feed Rate, tpd	Reactor		Reactant	Gas Exit Temperature, °C
					Pressure, psi	Temperature, °C		
30. TPS- Thermal Process Studsvik (Studsvik Eneriteknik AB)	Circulating Fluidized Bed	Woody biomass	Fuel gas	13-78	14.7	700-900	Air	
31. Lurgi Energy	Circulating Fluidized Bed	Bark	Lime kiln firing	120	14.7	800	Air	600
32. Aerimpianti (subsidiary of Ansaldo)	Circulating Fluidized Bed	RDF	Cement kiln firing	48-110	7.25	850-900	Air	800-900
33. Foster Wheeler (formerly Ahlstrom)	Circulating Fluidized Bed	Wood	Lime kiln firing, Electricity production	16	14.7	905	Air	700
34. Sydkraft AB (in cooperation with Foster Wheeler)	Circulating Fluidized Bed	Wood	IGCC - electricity and district heating (6 MW _e and 9 MW _t)		261	950-1000	Air	

Figure 4.1 – Logic Diagram For Screening And Matching Different Gasification Technologies And End-Use Applications

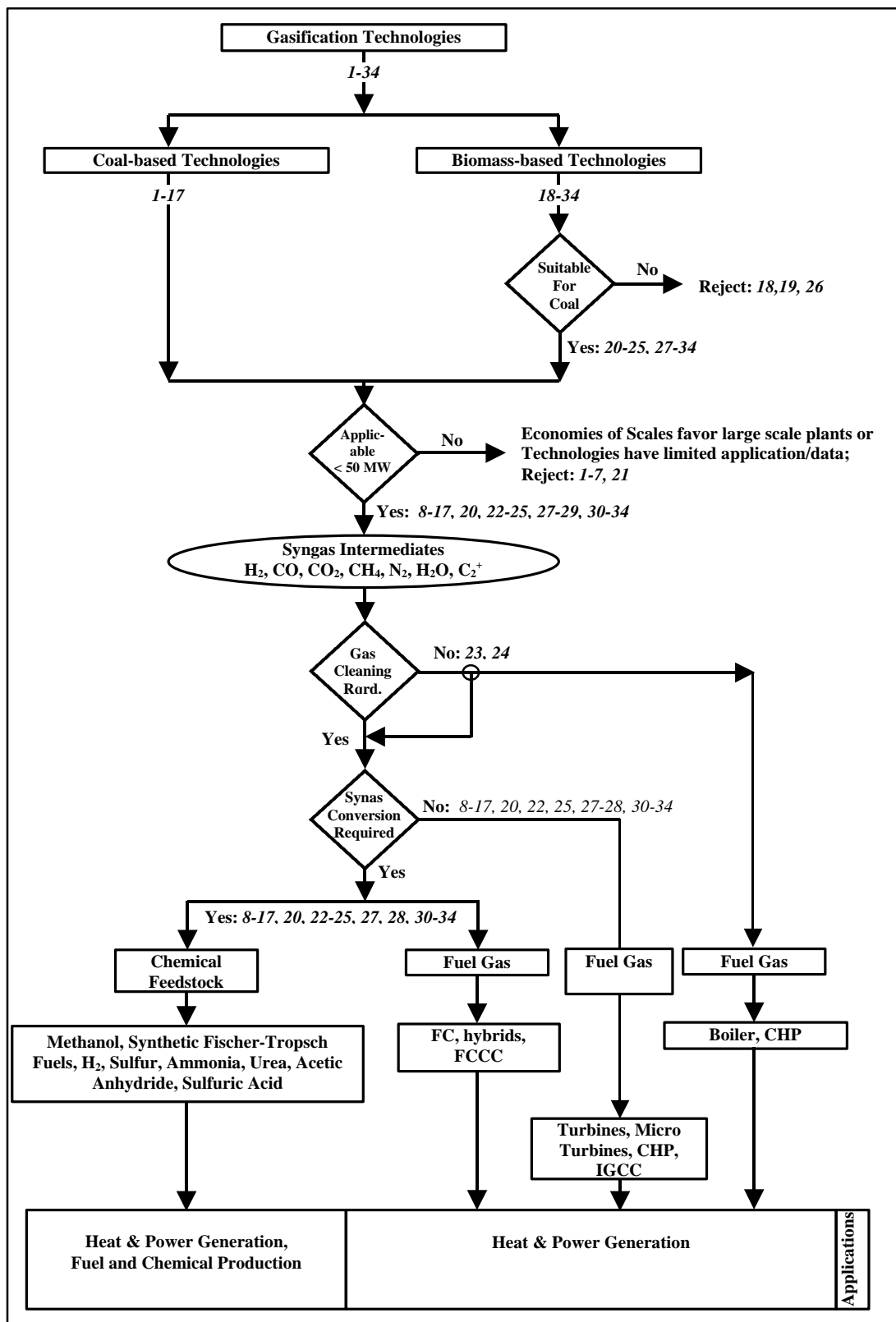

In general, economies of scale of the entrained-flow, oxygen-blown, coal gasifiers favor large-scale (greater than 250 MW_e) utility applications. Therefore these gasifiers, No.1 –7, are not considered to be applicable for small-scale, distributed power generation.

As indicated in Figure 4.1, some of the biomass gasification technologies (Wellman Process Engineering (No. 18), Volund (No.19), and ASCAB/Stein Industrie (No. 26)) are not considered suitable for coal gasification applications. This determination was made because technology developers have abandoned further development of these technologies or, according to the technology developers they have been developed specifically for small-scale, woody biomass applications.

Of the remaining 24 gasification technologies that are considered to be potentially suitable for small-scale, distributed power generation, 17 are of the fluidized-bed type and five (5) are fixed or moving bed type. ***This is indicates that industry effort for small-scale gasification technology, for both coal and biomass, is primarily focused on fluidized-bed technology.***

5. Syngas Applications For Power And Heat Generation

5.1 Conventional Power and Heat Generation

Straight combustion of coal-based syngas fuels in boilers is a fully developed technology. There are no advantages to such systems from an efficiency or environmental standpoint. Steam boilers can tolerate some levels of contaminants, including chlorines, particulates, and sulfur. In general, there do not appear to be any technical reasons that may impede any of the technologies screened in Figure 4.1 from being utilized to produce syngas for firing in boilers in the 50 MW and below range.

Commercialization and R&D efforts largely focus on either cofiring biomass-derived syngas in coal-fired boilers or on co-feeding options due to the environmental benefits of biomass use. Cofiring technologies under development focus on biomass gasification technologies, where the syngas simply plays the same role as natural gas in a cofired coal-natural gas boiler. The fuel flexibility of these plants helps overcome concerns about variable biomass feedstock suppliers. Similarly, the cofiring of biomass-derived syngas in coal-fired boilers reduces emissions of coal-fired boilers. ***Atmospheric, air blown gasifiers are well suited for this application.***

PERI believes cofiring biomass-derived syngas in coal-fired boilers is likely to find niche applications and that for the most part, proof-of-concept demonstrations are all that is needed to gain reliable operating experience.

5.2 Integrated Gasification Combined Cycle (IGCC) System

IGCC is now a commercial technology and early plants in 1980s and 1990s have demonstrated the technical and environmental benefits of this technology. According to GE¹³, IGCC development programs have allowed the introduction of a complete product line covering the full range of GE gas turbine sizes. ***The higher output units are recommended for plants where efficiency is most important and the lower rating units for plants where the total plant capital costs are the most important criteria.***

Aeroderivative generation turbines are available from 3 to 50 MW capacities while industrial gas turbines are available in 1 to 250 MW capacities. The industrial machines are generally less expensive, more rugged, and can operate a longer time between overhauls and inspections than the aeroderivative generation turbines. Aeroderivative turbines are, however, more efficient. Small aeroderivative and industrial turbines including Solar Spartan, EGT Typhoon, Westinghouse 251B12, and GE LM2500 have been tested and operated on low Btu gas.^{14,15} The GE LM2500 is capable of generating about 30 MW in a combined cycle configuration using low Btu gas.

¹³ D.M. Todd, *Clean Coal and Heavy Oil Technologies for Gas Turbines*, GE Industrial & Power Systems, GER-3650D.

¹⁴ C.R. Rurvis and J.D. Craig; *A Small Scale Biomass Fueled Gas Turbine Power Plant*, The Eighth Biennial National Bioenergy Conference, October 1998.

¹⁵ GE Press Release, February 27, 1997.

IGCC systems require the use of high-pressure gasifiers or the compression of the syngas. Gas turbines need a minimum gas pressure of 100 psig for the smallest turbines with substantially higher pressures required for the larger and aeroderivative turbines. Use of high-pressure, high-temperature syngas also improves the efficiency of the IGCC systems. These requirements favor high-pressure gasification with high temperature gas clean up systems. ***High temperature gas clean-up systems are currently being demonstrated but are not commercially available. Gas turbine technology is available for integration with air- or oxygen-blown gasification processes. However, the current economics of coal-based IGCC technology favors large-scale applications. High concentrations of hydrogen in some syngas products is also a concern to turbine manufacturers.*** Use of opportunity fuels or fuels with a negative cost such as heavy oils, municipal wastes, wastewater treatment sludge, and farm waste mixed with coal could improve the economics of small IGCC systems. Disposal of these waste materials is expensive; the tipping fee for the disposal of waste in the northeast region of the United States is currently estimated to be \$55 to \$85 per ton of waste. The availability and quality of waste materials as well as long-term trends in tipping fees should be examined to assess the long-term availability and costs.

5.3 Fuel Cell Systems

A detailed description of the fuel cell technology status and applications is provided in the *Fuel Cell Handbook*.¹⁶ Fuel cells produce direct current electricity through an electrochemical process. Reactants, most typically hydrogen and air, are continuously fed to the fuel cell reactor and power is generated as long these reactants are supplied (Figure 5.1).

Operation of complete, self-contained, natural gas-fueled small (less than 12 MW) power plants has been demonstrated using five different fuel cell technologies. They are: polymer electrolyte fuel cell (PEFC), phosphoric acid fuel cell (PAFC), alkaline fuel cell (AFC), molten carbonate fuel cell (MCFC), and solid oxide fuel cell (SOFC). Over 200 PAFC have been sold worldwide since early 1990s when 200kW PAFC units were commercially offered by IFC. These systems were installed at natural gas-fueled facilities and are currently in operation. Lower capacity units operate at atmospheric pressures while an 11 MW system that went into operation at the Tokyo Power Company's Gio Thermal Station in 1991 operates at eight atmospheres. MCFC units rated at 300kW are also considered ready for commercialization.

PEFC, AFC, and PAFC operate at low temperatures, less than 500°F, while MCFC and SOFC operate at high temperatures, 1,200°F – 1,850°F. Operating pressures also vary from atmospheric pressures to about eight atmospheres depending on the fuel cell type and size. Pressurization generally improves fuel cell efficiency¹⁷ but increases parasitic load and capital cost. It could also lead to operational difficulties such as corrosion, seal

¹⁶ *Fuel Cell Handbook, fifth edition*, U.S. DOE Office of Fossil Energy's National Energy Technology Laboratory, October 2000.

¹⁷ Sy A. Ali and Robert R. Mortiz, *The Hybrid Cycle: Integration Of Turbomachinery With A Fuel Cell*, ASME, 1999.

deterioration, and reformer catalyst deactivation. Most fuel cells require a device to convert natural gas or other fuels to a hydrogen-rich gas stream. This device is known as a fuel processor or reformer.

Figure 5.1 – Fuel Cell Concept

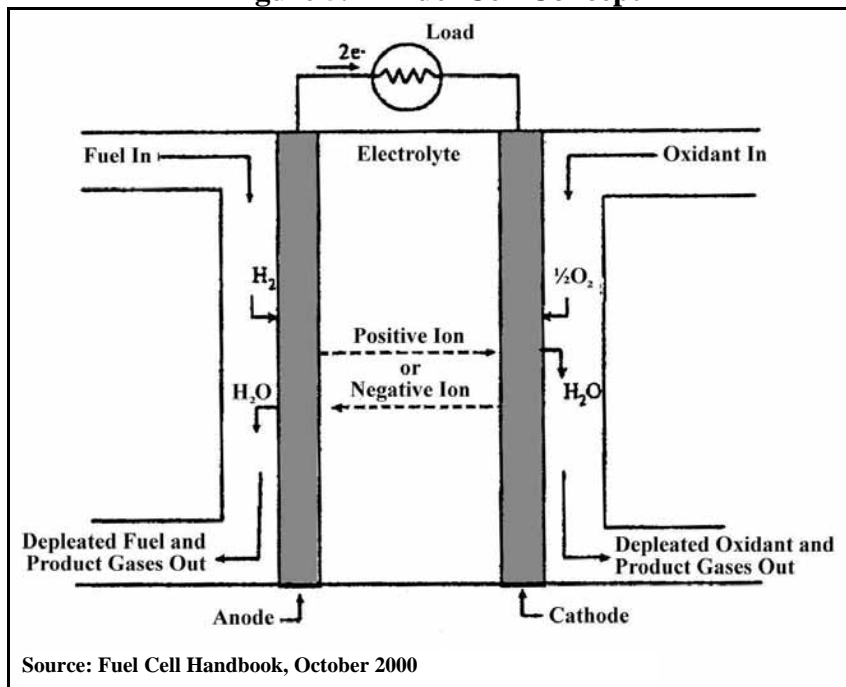

Fuel cell system performance is also sensitive to a number of contaminants. In particular, PEFC is sensitive to carbon monoxide, sulfur, and ammonia; AFC to carbon monoxide, carbon dioxide and sulfur; PAFC to carbon monoxide and sulfur; MCFC to sulfur and hydrogen chloride; and SOFC to sulfur. Fuel cell system design must reduce these contaminants to levels that are acceptable to fuel cell manufacturers.

In addition to the contaminants noted above, a number of compounds that are generally found in syngas from coal including hydrogen chloride, phenols, tars, and particulates, pose a challenge to integrating gasification and fuel cell systems. Specially, *it is doubtful whether low temperature fuel cells can be integrated with gasification systems.*¹⁶ MCFC is also reported not to withstand the level of chloride ion (Cl⁻) that is generally found in the coal-derived syngas. *The impact of chloride ions on SOFC is not known.* However, fuels containing carbon monoxide and ammonia, which are poisonous to other fuel cells, can be used in SOFC.

Regardless of fuel source, fuel cells are not currently cost competitive with gas turbines in the 10 MW to 50 MW range. The current initial installed cost of over \$3,000/kW¹⁸ continues to be a major barrier to a wider application of fuel cells for stationary power

¹⁸ *Natural Gas Infrastructure Limitations to the Application of Distributed Generation Technologies*, prepared for NETL by E²S, EEA, and PERI, Draft Final Report, June 2002.

generation. This installed cost is, however, projected to decrease to about \$400/kW by 2015.

5.3.1 Integrated Gasification Fuel Cell Systems (IGFC)

In some respects the market challenges facing IGFC systems are not that different from the market challenges faced by IGCC systems. These systems have to compete with natural gas-fired fuel cells and combined cycles on capital and operating costs, reliability, and availability. *The overall efficiency and technical performance of these systems has to be improved and their capital and operating costs have to be reduced significantly for these systems to become more competitive in the 10 –50 MW distributed power generation market.*

Niche markets where natural gas is not readily available or opportunity fuels are abundant continue to offer the best market opportunities for IGFC systems particularly if environmental issues are a major concern. Potential for the generation and storage of hydrogen, when power is not needed, is one of the key advantages of these systems.

While fuel cells are very efficient, not all the energy in the fuel is electrochemically converted to electric power.¹⁹ For example, only 50% of the fuel energy is converted to electric power by a SOFC or MCFC. In a basic natural gas-fueled fuel cell system (Figure 5.2), unreacted fuel and oxidant leaving the fuel cell are combusted to sufficiently increase the process temperature to generate steam for cogeneration or to drive a steam turbine.

Most industry and government funded efforts for the development of fuel cell systems have focused on the development of natural gas-fueled fuel cells and on improving system efficiency to reduce emissions and costs. *Technical, environmental and economic performance of integrated high temperature fuel cell systems and small gasification systems using coal, or combined coal and biomass, has not been extensively studied and the technical requirements of syngas cleaning and processing are not fully established yet.*

Development of natural gas-based hybrid systems, with generating capacities of up to 40 MW, has been investigated by Energy Research Corporation, (now Fuel Cell Energy), M-C Power Corporation, Siemens-Westinghouse, Allison Engine Company, Solar Turbines and others. Various system configurations for integrating low and high pressure, high temperature fuel cells with gas turbines have been proposed.^{16, 17, 20, 21} Figure 5.3 shows low pressure hybrid fuel cell systems. In these systems, waste fuel from the fuel cell

¹⁹ *Proceedings Of The Workshop On Very High Efficiency Fuel Cell/Gas Turbine Power Cycles, U.S. DOE, October 1995.*

²⁰ *High Efficiency Fossil Power Plants (HEFPP) Conceptualization Program, Energy Research Corporation, U.S. DOE Contract No. DEAC26-98FT34164, March 1999.*

²¹ *High Efficiency Fossil Power Plant (HEFPP) Conceptualization Program, M-C Power Corporation, U.S. DOE Contract No. DE-AC26-98FT40356-02, March 1999.*

anode is combusted in an external combustor or oxidizer to heat air supply to a fired or unfired turbine. The exhaust from the cathode is used to generate steam.

Figure 5.2 - Examples of Natural Gas Based Basic Fuel-Cell System

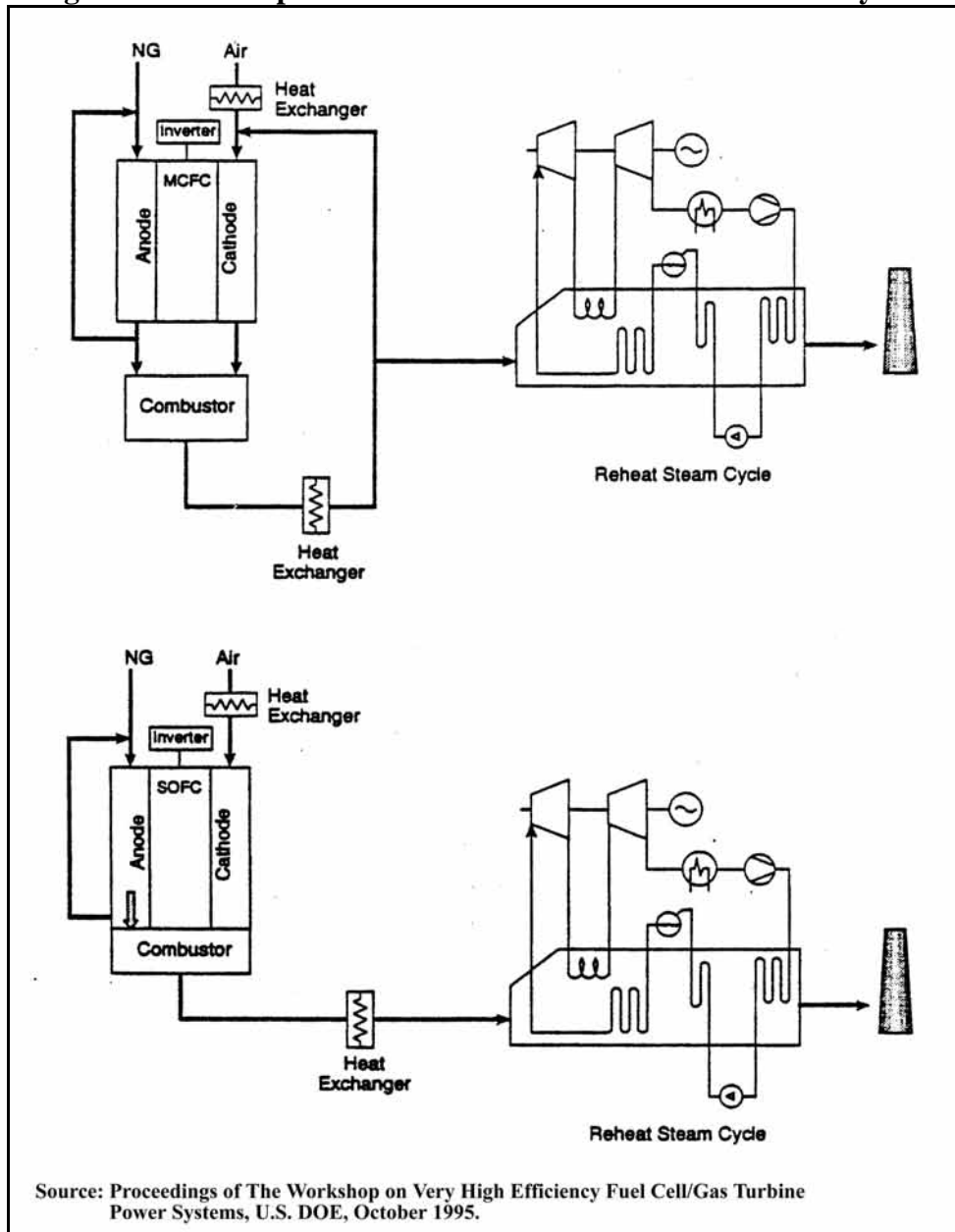

Source: Proceedings of The Workshop on Very High Efficiency Fuel Cell/Gas Turbine Power Systems, U.S. DOE, October 1995.

Figure 5.3 - Low Pressure Hybrid Fuel Cell System

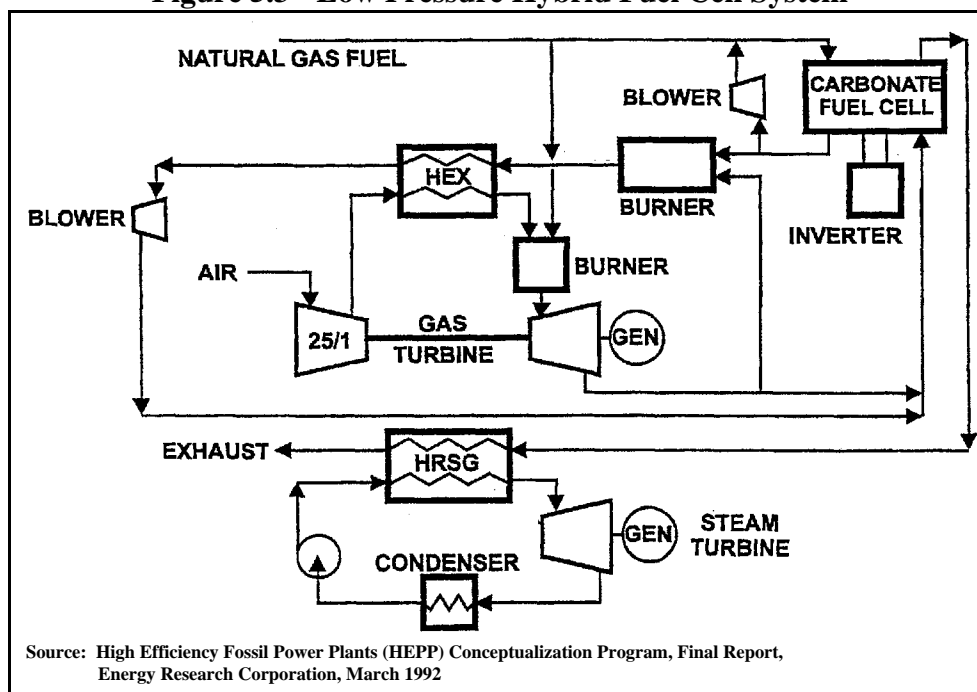

In a pressurized system (Figure 5.4), air is first pressurized for use in the fuel cell and waste fuel from the fuel cell anode and cathode exhaust, is then combusted to drive a turbine generator. The turbine exhaust is then used to generate steam to drive a steam turbine.

It is suggested that use of a recuperative heat exchanger between the turbine exhaust and fuel cell inlet air can achieve the same high system efficiencies without resorting to an external bottoming cycle.¹⁷ An example of such a system is shown in Figure 5.5. A second and more effective way may be to recirculate hot anode exhaust with some of the cathode exhaust to heat the fuel cell inlet gases enough to eliminate the need for a recuperator.¹⁷ This cycle is reported to be effective over a wide range of existing industrial gas turbines including some of the aeroderivatives.¹⁷ Recirculation also results in a lower turbine exhaust flow at a higher temperature which is often more suited for cogeneration.

As stated earlier, most industrial- and government-supported, fuel cell research has focused on developing very efficient, natural gas-fueled systems. *System studies are needed to identify gasification processes that can support low- and high- pressure hybrid fuel systems. The initial emphasis should be on atmospheric fluidized gasification systems that maximize hydrogen generation. Development of high-temperature gas cleanup systems could facilitate integration of high-pressure gasification and hybrid fuel systems.*

Since CO₂ sequestration may be required, several options need to be considered. These options include:

Figure 5.4 - High Pressure Hybrid Fuel Cell Systems

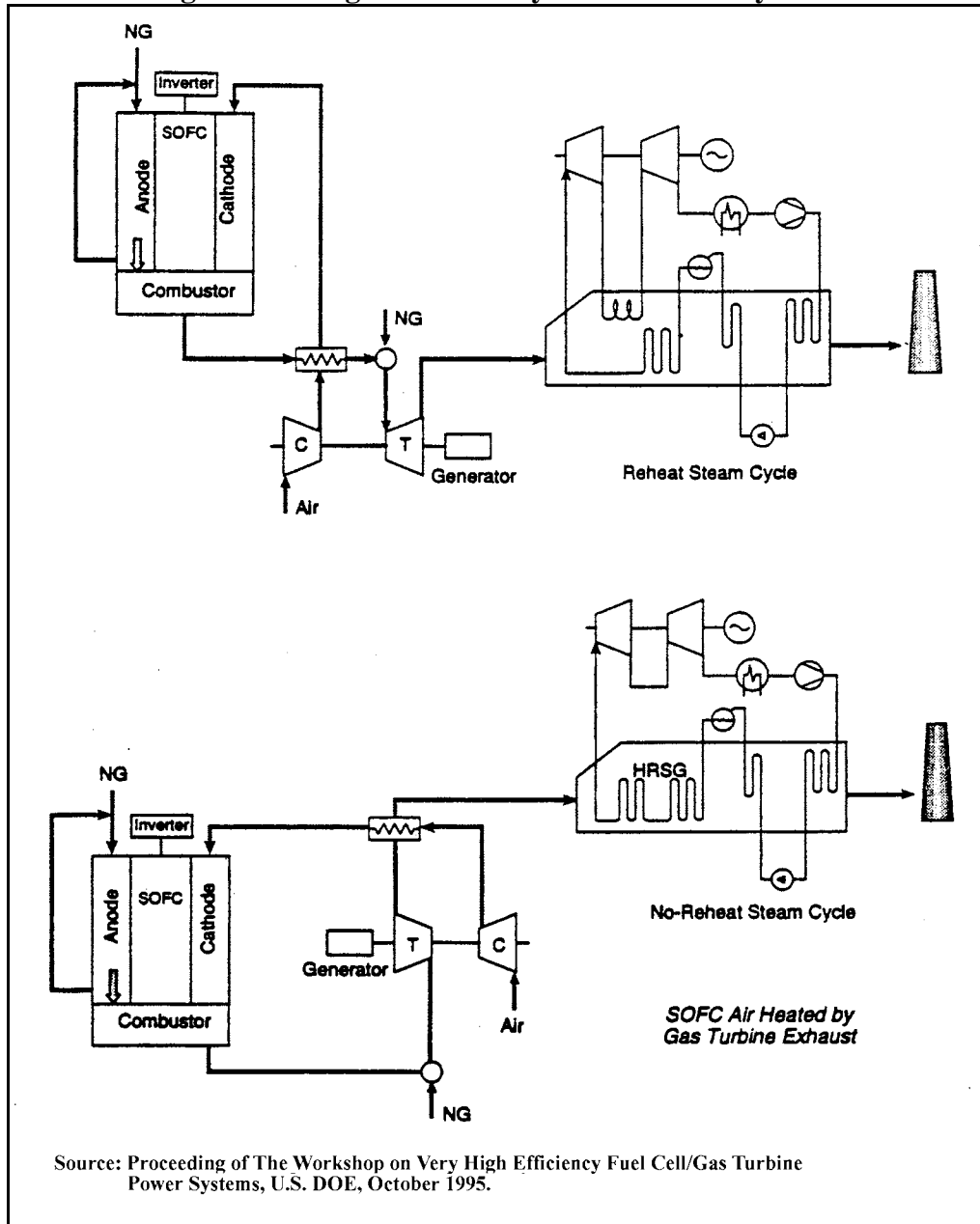
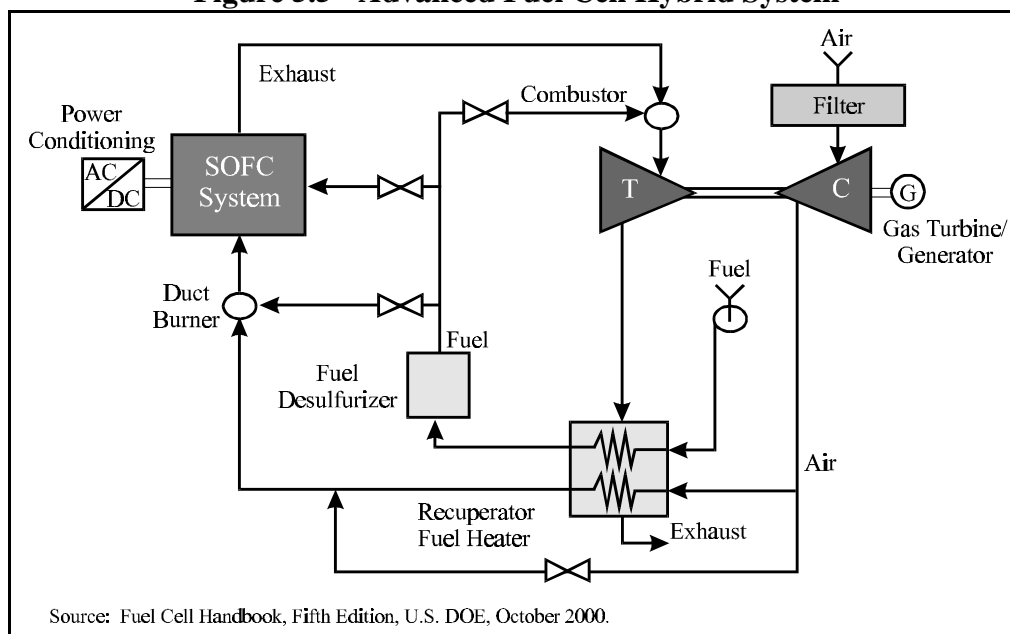

Figure 5.5 - Advanced Fuel Cell Hybrid System



1. Removal of CO₂ from syngas without shifting CO and utilizing the remaining syngas (CO and H₂) in a combustion turbine or fuel cell. Using oxygen could further concentrate the resulting CO₂ in the combustion gases.
2. Shifting CO to CO₂, separating CO₂, and utilizing the remaining syngas or hydrogen as fuel for fuel cells.
3. Separate hydrogen from un-shifted syngas for fuel cell applications or other uses and firing the remaining syngas in a combustion turbine.

The technical and economic viability of these options will depend on the quality of the syngas, the end use applications such as fuel cell type, and CO₂ economic value.

Siemens Westinghouse is developing a SOFC that includes an oxidizing process that converts the anode effluent gas essentially to CO₂ and water vapor. In this case option 1 may be more economic than options 2 or 3.

An alternative to direct separation and sequestration is developing and designing gasification plants that utilize energy crops and coal. These plants can be designed so the amount of CO₂ produced from coal would be equal to the amount of CO₂ consumed by the energy crop specifically grown for utilization as fuel for the plant.

At the present time, it is difficult to assign a market-based economic value to CO₂ separation and sequestration. However, CO₂ credits ranging from \$1.15 - \$25 per ton of CO₂ have been negotiated under the Joint Implementation Program.²²

²² John Rezaian's meetings with Eastern and Central European industry and government officials in September 2002 for preparing *USTDA Regional Waste-to-Energy and Renewable Energy Project*

6. Conclusions

Figures 6.1 and 6.2 conceptually illustrate the relationship between fuel costs, capital costs, and various power generation systems emissions. Increasing public and government demand for more environmentally friendly power generation systems is driving the power generation industry to switch to cleaner and more expensive fuels such as natural gas and hydrogen. As demand for cleaner and more expensive fuels increases, more efficient power generation systems are also desired. However, these more efficient systems are also more capital intensive. These increases in capital and fuel costs also favor larger, centralized power generation plants, at least initially.

Because of economies of scale and the needs of the utility industry, most industry and government efforts in coal gasification are directed toward the development of large-scale, centralized power plants. ***Most IGCC R&D efforts also appear to be geared toward improving the efficiency and economics of pressurized, oxygen-blown, entrained-flow gasification systems, which are favored for large-scale power generation.*** R&D efforts for the development of fuel cell technology and for distributed power generation are primarily focused on natural gas-fueled systems. These efforts can also help in the development of small-scale (10 - 50 MW_e) IGCC, IGFC, and integrated gasification hybrid fuel cell (IGHFC) systems.

Of all the small-scale gasification systems investigated, two appear to have the potential for competing commercially within the next decade. They are the MTCI and the FERCO steam reforming processes. However, system studies are needed to address optimal system configurations as well as fuel transportation, storage, and processing issues. The environmental performance of these systems is also expected to improve when coal and biomass are co-gasified. Co-gasification of coal and biomass can reduce emissions of CO₂, NO_x, and SO₂ and systems can be designed so that the total CO₂ emitted is the same as the amount of CO₂ that the biomass absorbs in its growth.²³

Transportation, processing, and storage of coal and biomass fuels, however, impedes the application of gasification systems unless good access to fuel and other infrastructure (transmission, water, permitting, etc.) exists. In a recent study²⁴, space requirements for the storage and processing of biomass was a primary concern of a U.S. utility considering biomass gasification for cofiring in a coal-fired boiler. A survey of industry²⁵ indicates that in the short-term, project economics, particularly the price and supply outlook for natural gas, will be the most important determinant in the deployment of gasification systems. Even at stable natural gas prices of \$2.50 per million Btu, the prospect for new IGCC systems is considered favorable against future fuel price volatility. This is especially true where good access to coal and other solid fuels or petroleum coke and

Reference Guide and supporting USTDA Regional Waste-to-Energy and Renewable Energy Conference, Prague, Czech Republic, December 2002.

²³ Dr. Ing. Giovanni Pino, Dr. P.P. Milella, Dr. Ing. F. Tunzio, Prof. Ing. G. Spazzafumo, *International Conference on Clean Coal Technologies for Our Future*, October, 2002.

²⁴ Private client study, PERI, December 2002.

²⁵ *DOE's Gasification Industry Interviews: Survey of Market Trends, Issues and R&D Needs*, U.S. DOE, Gasification Technology 2001, San Francisco, California, October 2001.

Figure 6.1 - Power Generation Technologies Capital And Fuel Costs Matrix

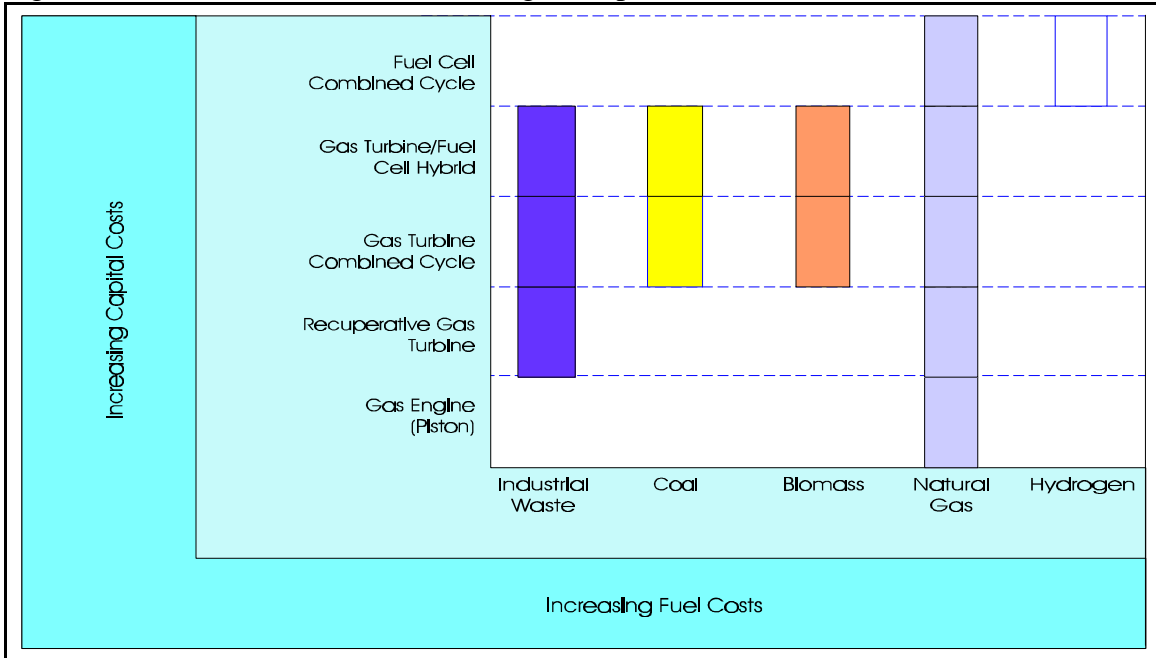
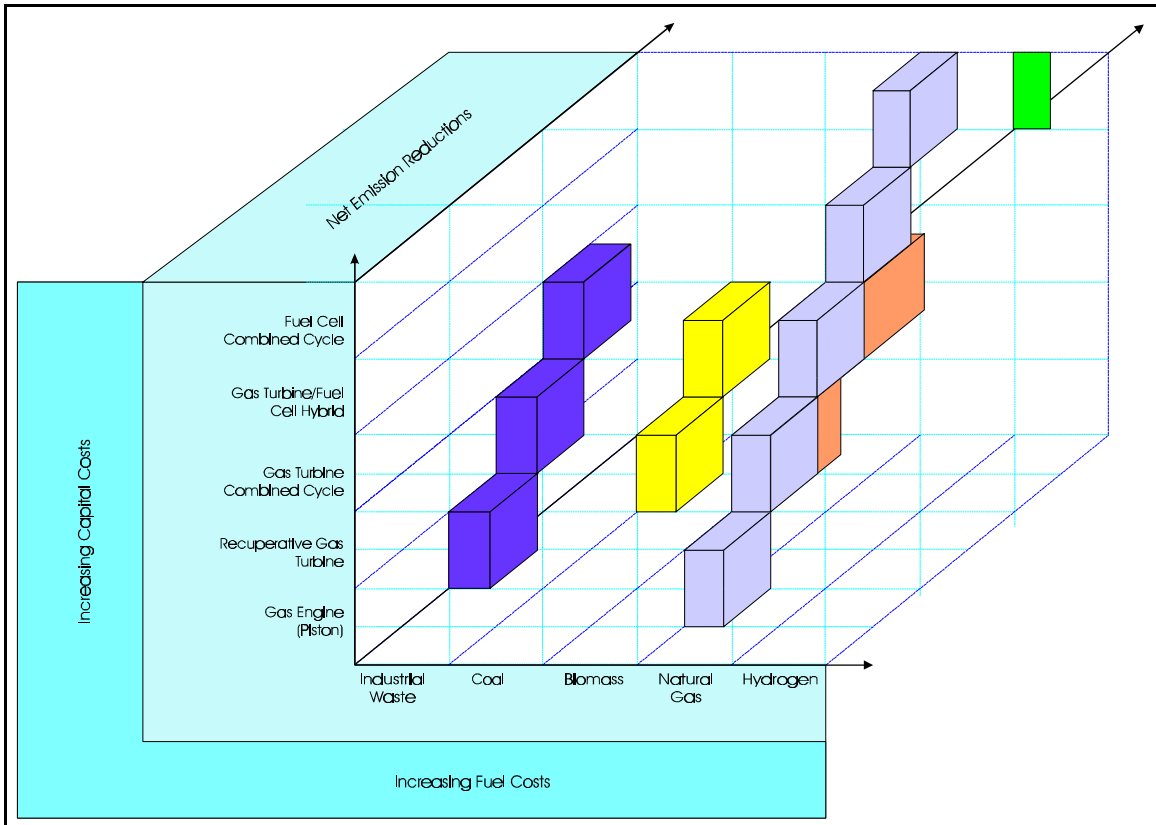

Figure 6.2 - Power Generation Technologies Capital Costs, Fuel Costs And Emission Reduction Matrix



heavy fuel oil as well as infrastructure exists. This survey further indicates that in the long-term (beyond 2010), the likelihood of coal use for power generation is expected to be greater due to improvements in both economics and system reliability and due to the increased importance of national security issues. The economics of small-scale systems is expected to compete favorably against large centralized power plants. Small-scale, distributed generation plants can benefit from avoidance of transmission losses or from the unavailability or high cost of grid-connected power.

The gasification technology, for both coal and biomass, most suited for small-scale applications appear to be atmospheric, air-blown, fluidized (bubbling and circulating) bed technology, primarily due to its lower capital costs. These systems can provide fuel for steam boilers and can be integrated with low-Btu gas turbines, but may not be best suited for integration with fuel cell systems. ***The large quantity of nitrogen in the syngas increases the syngas processing costs for fuel cell applications and CO₂ separation costs should CO₂ sequestration be required. An exception is indirectly heated fluidized-bed steam reforming technology.*** Steam reforming technology, such as the MTCI or the FERCO technology, produces a medium-Btu syngas that has higher concentration of hydrogen and carbon monoxide, lower concentrations of carbon dioxide and methane, and very little or no nitrogen. These processes operate in 1,100°F –1,500°F. Increasing the steam reformer operating temperature favors the carbon-steam gasification reaction, increasing the hydrogen and carbon monoxide content of the syngas. However, increasing steam reformer temperature is limited by the ash fusion temperature and could also negatively impact refractory life as well as that of other system components like fuel injection nozzles and in-bed fired tubes.

The technical, environmental, and economic performance of integrated high temperature fuel cell systems and small gasification systems using coal or combined coal and biomass has not been extensively studied. ***The technical requirements of syngas cleaning and processing are not yet fully established for long-term operations.*** Coal- or biomass-based syngas must be cleaned to remove particulates and contaminants to meet gas turbine manufacturers' fuel specifications and may have to undergo further processing to meet fuel specifications for fuel cells. ***Low temperature gas cleaning processes are commercially available; however, amine-based systems may not be suited for fuel cell applications.*** High temperature or warm gas cleaning systems are being demonstrated but are not commercially available. The gas cleaning and syngas processing requirements will vary depending on the fuel cell type. ***Integrated system studies are needed to address these issues and identify system components that could significantly reduce the overall system capital and operating costs.***

Should CO₂ sequestration be required, several options may be available for minimizing, separating, and/or concentrating CO₂. ***The technical and economic viability of these options will depend on the quality of the syngas and end use applications such as fuel cell type and CO₂ market value.***

An alternative to direct separation and sequestration is developing and designing gasification plants that utilize energy crops and coal. These plants can be designed so the

amount of CO₂ produced from coal would be equal to the amount of CO₂ consumed by the energy crop specifically grown for utilization as fuel for the plant.

7. Recommendations

The following R&D efforts are believed to be necessary in accelerating commercialization of small-scale gasification systems and are recommended for further consideration:

1. Conduct detailed systems studies of the MTCI and FERCO systems to identify syngas cleaning and processing requirements and optimum system configuration.
2. Demonstrate fuel cell operations using steam reformer syngas.

The following R&D efforts could lead to “leap frog” advancements of coal-based distributed generation systems:

1. Continue development of the high temperature gas cleaning and reforming processes for gas turbine and high-pressure fuel cell applications.
2. Demonstrate coal/biomass steam reforming as an effective method for reducing CO₂.
3. Identify and evaluate hydrogen and CO₂ separation techniques and assess the technical and economic potential of “pre- and post-power generation” CO₂ removal approaches for hybrid fuel cell systems.
4. Evaluate the technical and economic merit of separating the hydrogen content of syngas and combusting the remaining gases with oxygen for gas turbine applications and concentrating CO₂ for removal.
5. Develop strategies for addressing coal transportation, processing and storage issues for small-scale, distributed generation systems.
6. Develop strategies for addressing syngas storage and transport, and evaluate the potential use of existing natural gas networks to meet the transport needs of large, centralized coal-based syngas production facilities.
7. Develop strategies for the development of hydrogen storage and transport systems for hydrogen and other coal-derived fuels that can easily be processed for fuel cell applications at the point of use.

It is also recommended that follow-on efforts be implemented as noted below:

Conduct a series of meetings with senior managers at DOE’s Office of Fossil Energy and executives of selected gasifier and fuel cell developers and manufacturers, and utility and independent power producers to determine near-, mid-, and long-term market potential for, and barriers to, commercialization of the small-scale gasification systems, economic incentives that could be adopted, and the appropriate role that DOE could play to accelerate market acceptance of these technologies.

Appendix I
Coal Gasification Technologies

Entrained-flow Technologies

Hitachi: This coal gasification technology is based on an oxygen-blown Entrained-flow gasifier where the majority of experience has been gained in a 150 t coal/d unit. The gasifier is a water-cooled tube which is lined by a high temperature resistant castable. Pulverized coal is pneumatically transported by nitrogen to the gasifier where it is injected into the gasifier chamber through two types of burners at a pressure of 2.5 MPa. The two sets of burners are installed tangentially to the gasifier sidewall allowing a spiral flow of coal and oxygen from the upper stage to the lower stage and making particle residence times much longer than those of a gas stream. Enough oxygen is fed to the lower burner to melt the slag. Molten slag solidifies on the gasifier wall as a first layer and subsequent molten slag flows over the layer of the solidified slag to the slag tap hole at the bottom of the gasifier and it is quenched with water and finally removed via a lock hopper. Coal fed to the upper burners is reacted at lower temperature with a smaller amount of oxygen; it is then gasified and converted to reactive char. The char moves down along the spiral gas flow and mixes with high temperature gas in the lower portion of the gasifier, where gasification proceeds further. The raw gas produced together with the fly ash and the remaining char particles go up toward the exit of the gasifier. They enter a syngas cooler where they are cooled to 450°C prior to going through a cyclone and a filter which retain most of the fly ash and the char particles which are finally reinjected into the gasifier by pneumatic transport under nitrogen. The syngas goes successively through a water scrubber to remove halides and is desulphurised to be cleaned enough to comply with the strict tolerance limits of fuel cells.

SCGP: The Shell Gasification Process can operate on a wide variety of feedstocks. It consists of three principal stages:

1. Gasification (Partial Oxidation), in which the feedstock is converted to syngas in the presence of oxygen and a moderating agent (steam) in a refractory-lined gasification reactor
2. Syngas Effluent Cooler (SEC), in which high pressure steam is generated from the hot syngas leaving the reactor
3. Carbon Removal, in which residual carbon and ash are removed from the syngas in a two-stage water scrubbing unit

The Shell gasifier is a dry-feed, pressurized, entrained slagging gasifier. Feed coal is pulverized and dried with the same type of equipment used for conventional pulverized coal boilers. The coal is then pressurized in lock hoppers and fed into the gasifier with a transport gas by a dense-phase conveying system. The transport gas is usually nitrogen; however, product gas can be used for synthesis gas chemical applications, where nitrogen in the product gas is undesirable. The oxidant is preheated to minimize oxygen consumption and is mixed with steam as a moderator prior to feeding to the burner. The coal reacts with oxygen at temperatures in excess of 2500°F to produce principally hydrogen and carbon monoxide with little carbon dioxide. Operation at elevated temperatures eliminates the production of hydrocarbon gases and liquids in the product gas. The high-temperature gasification process converts the ash into molten slag, which

runs down the refractory-lined water wall of the gasifier into a water bath, where it solidifies and is removed through a lock hopper as a slurry in water. Some of the molten slag collects on the cooled walls of the gasifier to form a solidified protective coating. The crude raw gas leaving the gasifier at 2500-3000°F contains a small quantity of unburned carbon and about half of the molten ash. To make the ash non-sticky, the hot gas leaving the reactor is partially cooled by quenching with cooled recycle product gas. Further cooling takes place in the waste heat recovery (syngas cooler) unit, which consists of radiant, superheating, convection, and economizing sections, where high-pressure superheated steam is generated before particle removal. The first commercial IGCC plant using the Shell Coal Gasification Process is Buggenum in the Netherlands for which the construction was completed in 1993. The plant achieves an overall efficiency of 43% that could be increased to over 50% if the latest designed gas turbines were used. The Buggenum design processes coal with natural gas as back up. The plant can process up to 2000 t/d of fuel. A demonstration plant (220 t/d) at Oil Deer Park Manufacturing complex in Houston completed tests that provided the ability of the SCGP to gasify more diverse types of coals (220 t/d of bituminous coals or 365 t/d of high moisture, high ash lignite) before being shut down in 1991. Any coal that can be milled to the right size and pneumatically transported can be gasified in the Shell entrained-flow gasifier. Some adjustments have to be made in order to keep the SCGP performances optimal when changing coal. Bituminous coals require, in most cases, steam injection and oxygen/MAF (moisture and ash free) coal ratios from 0.85-1.05 for producing a syngas with a CO/H₂ ratio of 2.2-2.4 and 1-2.5% CO₂. Subbituminous coals and lignite's normally don't require steam injection and can be operated with oxygen/MAT coal's ratio between 0.8 and 0.9, producing syngas with some 3-5% CO₂ and a CO/H₂ ratio of 2.0-2.2. Anthracites require a higher oxygen/MAF coal ratio of 1.0-1.1, a higher steam/oxygen ratio of 0.15-0.3, and produce a syngas with similar CO₂ contents as bituminous coal (1-2.5% CO₂, but a higher CO/H₂ ratio of 2.4-2.6). The ash content of a coal has an impact on the performance of the SCGP process in terms of efficiency, as slag forms part of the insulation of the wall of the gasifier and is used to prevent excessive heat loss during the gasification reaction. Sulcis, a new IGCC project based on the SCGP technology was being developed in Sardinia, Italy. The project is presently in stand-by due to financial reasons but expected to go ahead. It was planned to have similar characteristics as the Buggenum plant. The Sulcis plant has been designed to gasify 5000 t/d of local coal blends (high sulfur, high ash sub-bituminous coal) and imported LHV coals. A large IGCC demonstration plant is also planned to be built at Yantai Power plant in Shandong province in China. Technical pre-feasibility studies were carried out in 1994-95. Development prospects were predicted and comparisons were made with CFBC, PFBC-CC and supercritical units. Two 400 MW IGCC units should be installed. Their net efficiency is planned to be more than 43%. They are designed to gasify bituminous coals with high sulfur content (2.5-3%) from Yanzhou in Shangong. Sulfur will be recovered as elemental sulfur with a predicted removal efficiency of 98%. Three other gasification plants are planned to be developed by Shell in partnership with Sinopec in China and a fourth one is under feasibility study. The plants will all produce syngas for ammonia/urea production or H₂ for other chemical plants (methanol, oxo), replacing naphta reformers, oil gasifiers or outdated coal gasifiers.

MHI: Mitsubishi Heavy Industries (MHI) is an air blown gasifier divided into two sections: a lower combustion section, which is connected by a diffuser to an upper reducing section. Dry pulverized coal is fed at two points into the gasifier with half of the coal being fed into the combustor together with air where it is burned to produce CO. The temperature inside the combustor is sufficiently high to melt the coal ash without the addition of flux. The slag runs to the bottom of the gasifier where it is quenched in a water bath and removed through a lock hopper system. The gas produced in the combustor rises to the reducing section where the remaining coal is added. Coal is then gasified in the reducing section to produce a low heating value syngas mainly formed of nitrogen. As the reducer section is at a lower temperature than the combustor section, any molten ash carried upwards is solidified. The syngas produced exits the gasifier through a syngas cooler. Cyclones are used to collect the char, as the coal is not completely gasified in the reducing section. Chars collected in the cyclones are then reinjected at the base of the gasifier to ensure complete carbon conversion. Because of the very high temperatures reached in the combustion section, this type of gasifier is well suited to gasify the very high ash-melting point Australian coals without any addition of fluxing agent. The MHI gasification technology has been tested in Nakoso (Japan) in two pilot-scale gasifiers. A new, 250MW_e project has been started in Nakoso that will process up to 1500 t/d of coal. The system will have a unique feature: the oxidizing gas will be partially extracted from the gas turbine compressor and will be enriched with oxygen coming from an independent air separation unit, making the gasifier operation more stable and giving a certain flexibility to the system that does not exist in the two highly integrated European IGCC plants. An advantage of the MHI two stage dry fed entrained-flow gasifier compared with the one stage gasifiers is that the syngas temperature at the outlet of the gasifier is not as high as the one flowing out of a one stage gasifier. This means that the process does not require a large radiant cooler or a quenching system to mix cold recycled gas with the syngas. The overall cost of the process should be less than that of existing IGCC plants. The raw gas produced together with the fly ash and the remaining char particles travel upward toward the exit of the gasifier. After leaving the gasifier, they enter a syngas cooler where they are

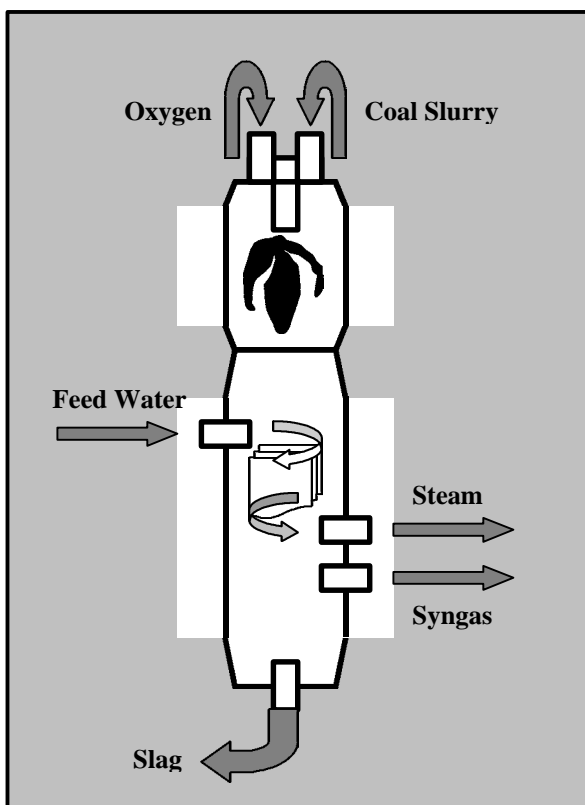

cooled to 450°C prior to going through a cyclone and a filter that retains most of the fly ash and the char particles. The collected fly ash and char is reinjected into the gasifier by a pneumatic transport system using nitrogen. The halides and sulfur compounds in the syngas are removed and the syngas is sufficiently cleaned to comply with the tolerance limits of fuel cells and gas turbines.

Texaco: The Texaco gasifier is a pressure vessel with a refractory lining which operates at temperatures in the 1250-1450°C range and pressures of up to three (3) MPa for power generation and 6-8 MPa range for H₂ and chemical synthesis. The feedstocks, oxygen and steam, are introduced through burners at the top of the gasifier. Solid feedstocks such as coal are pre-processed into a slurry by fine grinding and water addition. The slurry is pumped into the burner and the water, added with the slurry, replaces most of the steam that would normally be injected into the system. Raw gas and molten ash produced during coal gasification process flows out toward the bottom of the gasifier. Two optional alternatives are then available for the recovery of the ash and cooling the raw gas. The raw gas can either be cooled and cleaned from the slag ash by water quenching, or it can be cooled in a radiant syngas cooler from 1400 to 700°C. The heat recovered in the second option, is used to raise steam for use in the process or for power generation. Molten slag flows down the heat recovery steam generator and is quenched at the bottom of the cooler and finally removed through a lock hopper system. The quench alternative is the preferred option for coal feedstocks as they could contain traces of salts (sodium and calcium) that could be corrosive to the syngas coolers operating at high temperatures. However, this alternative has a slightly lower thermal efficiency. There are several existing projects using Texaco technology. Among them is an IGCC project, the Polk power station, managed by Tampa Electric Corp. During the first three commercial years of operation, ten different coals or coal blends were tested to identify the cheapest feedstock to process while achieving new environmental regulations. The slag removal system of the Polk power station is designed for processing coals with a maximum of 12% (Wt, dry basis) ash content. The operating temperature of the gasifiers has to be high enough for the coal mineral matter to melt and flow freely down to the bottom of the gasifier. Texaco has fixed the minimum heating value of the coals at 30 MJ/kg to produce enough syngas to fully load the combustion turbine. It would be necessary to increase the oxygen supply size as well as the slurry delivery system capacity to be able to run the plant with a lower heating value coal. The plant is designed to accommodate coals with sulfur contents of up to 3.5% (Wt dry basis). Following major problems, the company decided to switch to coal blends with lower sulfur contents. The limit in chlorine concentration in the coals was fixed at 0.15% (dry ash). A higher concentration of chlorine in coals would damage the system. Other coal properties have an influence on the technical and economic aspects of the Texaco based IGCC operation and necessitate coal testing prior to selecting them for the Polk Power Station. The Texaco technology is also used for chemical plants. Eastman Chemicals (Kingsport, USA) owns two Texaco quench gasifiers that operate at about 7MPa and 1400°C to produce a feedstock (i.e., syngas) for production of acetic acid and acetic anhydride. Although the facility is configured for the purpose of making acetyl chemicals, the company claims that gasification and clean-up plants are completely compatible with an electric power option and in fact an electric power option of 523 MWe is reported to be under development at Kingsport, Tennessee. This project is consistent with the new projects for cogeneration of chemicals and electricity sponsored by the US DOE under the Vision 21 program. Another U.S. company, Waste Management & Processors, Inc. (WMPI) is presently conducting a techno-economic feasibility study in partnership with Texaco, Sasol and Nexant for the development of one of the three Early Entrance Coproduction Plants

(EECP) demonstrations under the Fossil Energy Co-production Program. The objective is the commercialization of a coal gasification/liquefaction technology to produce ultra-clean Fischer-Tropsch transportation fuels with, either power, chemicals, or steam as co-products. The proposed plant location is at the Gilberton Power Plant cogeneration facility, Pennsylvania. It involves the gasification of local waste coals, mainly high ash content anthracite wastes derived from an on-site coal cleaning operation that contains coal fines, coal dust and dirt. Recently, the technology being evaluated in the WMPI coproduction activity was selected for further development as part of the Clean Coal Power Initiative (CCPI). Another demonstration EECP project is being developed by Texaco in collaboration with Rentech (Fischer-Tropsch Technology), Brown and Root services, Praxair and GE Power Systems for the production of electricity and chemicals from coal and/or petroleum coke. The project involves technical and economic studies of several process options, including syngas composition, Fischer-Tropsch product upgrading, wastewater treatment, catalyst/wax separation, acid gas removal, tail gas utilization and site selection. There is also a plan for the construction of a 430 MW IGCC plant based on the Texaco technology near the Hatfield colliery in the North of England. The IGCC project with CO₂ removal and production of H₂ is being studied by Jacobs consultancy in cooperation with GE. The IGCC power plant is configured to be capable of removing 75% of the feed carbon as CO₂ prior to combustion in the gas turbine. By performing a 'sour shift' of the syngas, most of the carbon monoxide should be converted into carbon dioxide and an equal volume of hydrogen. If carbon dioxide removal is performed then the fuel for the combustion turbine will consist mainly of H₂.

BBP: Babcock Borsig Power (Noell) technology, also known as the Noell entrained-flow technology, was first developed in 1975 in the former East Germany for the gasification of lignite in a three MW pilot plant. A full-scale (130 MW) gasifier was built in the 1980s to produce syngas and town gas. The technology was known as the GSP process before being acquired by Noell in 1991. The process features a dry or slurry feed, oxygen-blown, slagging gasifier. If solid fuel is to be gasified, it is first pulverized, then pneumatically conveyed to the feeding system and dry fed together with oxygen and steam through a burner located at the top of the gasifier. Depending on the fuel ash content, the gasification chamber can either be covered by a cooling screen or a cooling wall. Both the refractory and the solid slag provide thermal insulation and maintain the tube surface temperature below 230°C. To allow the solidified slag to regenerate continuously, only fuels with an ash content of more than 1% can be processed in the gasifier. Heat removed by the cooled tube wall represents 2-3% of the total heat produced during gasification and is used to generate low-pressure steam. Syngas saturated with water is further cooled to 150-200°C and recycled to the quench sprays within the gasifier. The bottom part of the gasifier consists of a quench bath, which cools and solidifies the slag. The slag is removed in a granular form. The only Noell gasifiers in commercial operation are at Schwarze Pumpe (Germany) and at the BASF Seal Sands located in Middlesbrough in the UK. The BBP Research and Development center based at Freiberg (Germany), comprises two facilities with capacities of 5 and 10 MW. The smaller one was originally designed in 1979 for the gasification of both solid and pulverized solid materials. The pilot plant is being used by the Dow Chemical for the development of technology for the gasification of chlorinated wastes. The second one was also designed for the gasification

of pulverized materials (coal, waste), liquids and slurries (waste oil, sludge, paint waste) and built in 1997. A wide range of coals from anthracites to brown coals have been gasified in the two pilot plants since the 1980s. BBP claims that it is capable of providing appropriate test conditions to optimize feedstock preparation prior to gasification as well as to determine the optimum gasification conditions for more than 80 different fuels including 30 coals.

E-GAS: The E-GAS (formerly Destec) coal gasifier is a slurry-feed, pressurized, upflow, entrained two-stage slagging gasifier. The dry coal concentrations in the slurry range from 50 to 70 wt %, depending on the inherent moisture and quality of the feed. Part of the coal slurry (80%) is injected with oxygen (95%) through two burners at the lower stage of the gasifier where it is partially combusted at a temperature of 1350-1400°C and a pressure of 3 MPa. Molten ash formed flows down the gasifier and is removed through a tap hole into a water quench. There is no lock hopper for ash removal. This technique has the advantage of

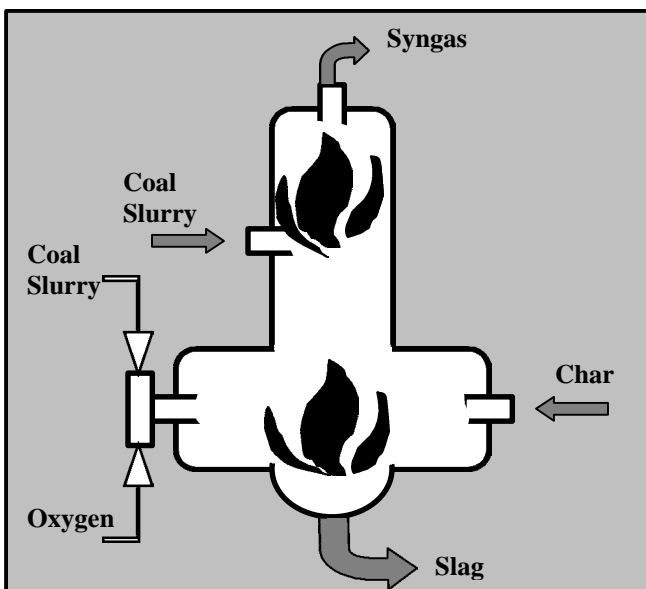

reducing the overall height of the system. The fuel gas produced in the lower stage flows upwards in the upper stage where it can react with the remaining 20% of the coal in the slurry. This two-stage process presents the advantage of producing a gas with a higher calorific value than that produced in a one-stage process. The crude gas exiting the gasifier at a temperature of around 1050°C is cooled to 370°C in a firetube syngas cooler. This unit generates saturated high-pressure steam. The firetube syngas cooler is a boiler system with the hot gas circulating on the boiler side as opposed to a water syngas cooler in which water circulates in tubes in a syngas tank. The firetube is reportedly considerably cheaper than the ones used in the Shell, Texaco and Prenflo processes. After the cooling step the syngas is cleaned with filters to remove large ash and char particles. This material is pneumatically reinjected into the gasifier. The filter elements made of metal for an acceptable resistance to corrosive syngas, are periodically back pulsed with high-pressure syngas to remove the particulate cake formed on their surface. The particulate cake falls to the bottom of the vessel and is pneumatically recycled together with the high-pressure syngas to the first stage of the gasifier. Finally the particulate-free syngas flows to the low temperature heat recovery system where it is scrubbed with sour water condensed from the syngas to remove troublesome chlorides and trace elements that could cause corrosion within the piping and vessels. After scrubbing and reheating, the syngas enters the COS hydrolysis unit where the COS present in the syngas is converted to H₂S. The syngas is then cooled through a series of shell and tube exchangers to 35°C before entering the acid gas removal system. This cooling step also condenses

water from the syngas. Most of the NH_3 and some of the CO_2 as well as H_2S present in the syngas are absorbed in the water as dissolved gases. Wabash River plant, in the U.S., is the only E-Gas gasifier in operation. In the early 1990s, prior to the repowering of the Wabash River plant to an IGCC, some tests of bituminous coals, including high sulfur coals, were performed in a 2200 t coal/d plant based in Plaquemine, Louisiana. The Wabash River power plant is designed to use a range of local coals with a maximum sulfur content of up to 5.9% (dry basis) and a higher heating value of 31.4 MJ/Kg (moisture and ash free). It is presently operating on Illinois No 6 coal. Alternative fuels (petcoke) have also been successfully tested at Wabash River and future tests may include coal fines. Coal fines are believed to be a promising fuel in the locality of the Wabash River facility as it is produced by the ongoing operations of the adjacent mine. They are also available from surface reserves where the fines have been land filled in the past. The fines are predicted to be 40-60% cheaper than the being coal delivered to the facility.

Prenflo: Coal is fed together with oxygen and steam through four burners located at the lower part of the gasifier. Syngas is produced at a temperature of 1600°C and is quenched at the gasifier outlet with recycled cleaned gas to reduce its temperature to 800°C . The syngas flows up a central distributor pipe and down through evaporator stages before exiting the gasifier at a temperature of 380°C . The raw gas is dedusted in two ceramic candle filters and a part of it is recirculated into the syngas cooler. The syngas is finally washed in a Venturi scrubber. Slag formed during the gasification process is quenched in a water bath and is removed through a lock hopper system. The only commercial-scale unit is located in Puertollano in Spain (capacity of 338 MWe). It is the largest unit worldwide utilizing solid fuels. The plant has been operating since 1996 and can process up to 2600 t/d of coal/petcoke fuel mixed with limestone (2% weight) and produces $180,000 \text{ m}^3/\text{d}$ of raw gas. The annual production of slag (85% of the ash in the coal by weight) and fly-ash (15% of the ash by weight) are respectively 120,000 t of and 12,000 t per year. The demonstration project has now attained commercial development with a gross efficiency of 47.2% (net efficiency of 42%).

Fluidized Bed Technologies

HTW: The HTW (High Temperature Winkler) process was first developed by Rheinbraun in Germany to gasify lignites for the production of a reducing gas for iron ore. The gasifier consists of a refractory-lined pressure vessel equipped with a water jacket. Feedstocks are pressurized in a lock hopper which is located below the coal storage bin and then pneumatically conveyed to a coal bin. The conveying gas is filtered and recirculated. Coal in the receiving bin is dropped via a gravity pipe into the fluidized bed, consisting of ash, semi-coke and coal. The gasifier is fluidized from the bottom with either air or oxygen/steam and the temperature of the bed is kept below the fuel ash fusion temperature. Additional gasification agent is introduced at the freeboard to decompose, at higher temperature ($900\text{-}950^\circ\text{C}$), undesirable by-products formed during gasification. The operating pressure can vary from 1 to 3 MPa, depending on the use of

the syngas. The raw syngas produced is passed through a cyclone to remove particulates and then cooled. Solids recovered in the cyclones are reinjected into the gasifier and dry ash is removed at the bottom via a discharge screw. The syngas cooling system has been the subject of study as to whether to use a water-cooled or a fire tube syngas cooler. The main reason was that the existing water-cooled syngas cooler was facing fouling and corrosion problems. A conventional water scrubber system was originally used for gas cleaning but due to blockages, fouling, corrosion, and also the high operating cost of the system, Rheinbraun decided to develop a hot gas filtration system. A hot gas ceramic candle unit formed of 450 candles was developed and operated for 15,000 hours. The HTW technology manufactured by Rheinbraun was successfully applied for the synthesis of chemicals (methanol) from lignite at Berrenrath (Germany) between 1986 and 1997. The plant was shut down at the end of 1997 as at the time the process was no longer considered to be economically viable. Another commercial plant has been operating in Finland since 1988, essentially with peat for the production of ammonia. A 140 t coal/d pressurized HTW gasification plant was also commissioned and built at Wesseling (Germany) in 1989, to supplement research and development of the HTW technology for coal use and particularly to study its future application to an IGCC process for power generation. The plant was designed for a maximum thermal capacity of 36 MW and was operated for three years either as an air-blown or an oxygen-blown gasification plant with pressures up to 2.5 MPa. A wide range of coals was tested in the Wesseling plant, including brown coals and a high volatile bituminous coal (Pittsburgh No 8). The Wesseling plant provided the operational data required to design a potential 300 MW commercial IGCC power plant (KoBra) which was finally never built. However, there is presently a project to develop a 400 MW IGCC plant based on the HTW technology (two units) to replace 26 existing Lurgi fixed-beds at Vresova in the Czech Republic. The new HTW plant (80 t/h coal and pressures up to 3 MPa) should operate on Czech lignite and will benefit from years of research and development at the Wesseling and Berrenrath plants. In order to adapt the HTW technology to the Czech lignites and also to the pre-existing Vresova IGCC plant (coal grinding plant, air separation unit, waste water treatment and steam turbine), tests were performed by Rheinbraun in a HTW bench-scale gasification unit and compared to results obtained with other coals in the same bench-scale unit and in a demonstration plant.

IDGCC: The IDGCC (Integrated Drying Gasification Combined Cycle) technology was specifically developed for the gasification of high moisture low rank coals by Herman Research Pty Limited in Morwell, Australia. The gasifier is a 5 MW air blown pressurized fluidized bed pilot plant that is fed with coal from an integrated drying process. The feed coal is pressurized in a lock hopper system and then fed into the dryer where it is mixed with the hot gas leaving the gasifier. The heat in the gas is used to dry the coal whilst the evaporation of water from the coal cools down the gas without the need of expensive heat exchangers. The gasifier operates at 900°C under 2.5 MPa air pressure. Chars and ash are collected at the bottom of the gasifier and from a ceramic filter and burnt in a separate boiler. The final ash product is similar to that from a conventional low-rank boiler. A wide range of low rank coals could be processed in the IDGCC, with only small changes in the operating conditions. Coals containing high levels of sulfur can be processed with sorbents, such as limestone or dolomite directly

injected into the bed. This would obviate the need for additional cooling of the gas to 40°C for sulfur removal from the very high moisture syngas. The extra cooling would have led to a very large energy loss from water condensation and reduced mass energy for the gas turbine. It is expected that the IDGCC could handle coals with lower moisture content and higher ash content. As the IDGCC plant is based on a fluidized bed gasification technology, it is then not recommended, as in most of the fluidized bed technologies, for coals with relatively low reactivities and coals with low ash melting points. When looking at environmental considerations and particularly at the concept of CO₂ removal and H₂ production, the IDGCC which produces a very moist syngas, can provide the water for the shift reaction without robbing or much reduced robbing of the steam cycle and may have potential for future development. It was reported that the IDGCC process is more efficient and as a consequence more environmentally friendly (lower CO₂ emission) than conventional processes, and would be just slightly less efficient than an Australian black coal IGCC process.

KRW: Coal and limestone, crushed to below 1/4", are transferred from feed storage to the KRW fluidized-bed gasifier via a lock hopper system. Gasification takes place by mixing steam and air (or oxygen) with the coal at a high temperature. The fuel and oxidant enter the bottom of the gasifier through concentric high velocity jets, which assure thorough mixing of the fuel and oxidant and of the bed of char and limestone that collects in the gasifier. Upon entering the gasifier, the coal immediately releases its volatile matter, which burns rapidly, supplying the endothermic heat of reaction for gasification. The combusted volatiles form a series of large bubbles that rise up the center of the gasifier, causing the char and sorbent in the bed to move down the sides of the reactor and back into the central jet. The recycling of solids cools the jet and efficiently transfers heat to the bed material. Steam, which enters with the oxidant and through a multiplicity of jets in the conical section of the reactor, reacts with the char in the bed, converting it to fuel gas. At the same time, the limestone sorbent, which has been calcined to CaO, reacts with H₂S released from the coal during gasification, forming CaS. As the char reacts, the particles become enriched in ash. Repeated recycling of the ash-rich particles through the hot flame of the jet melts the low-melting components of the ash causing the ash particles to stick together. These particles cool when they return to the bed, and this agglomeration permits the efficient

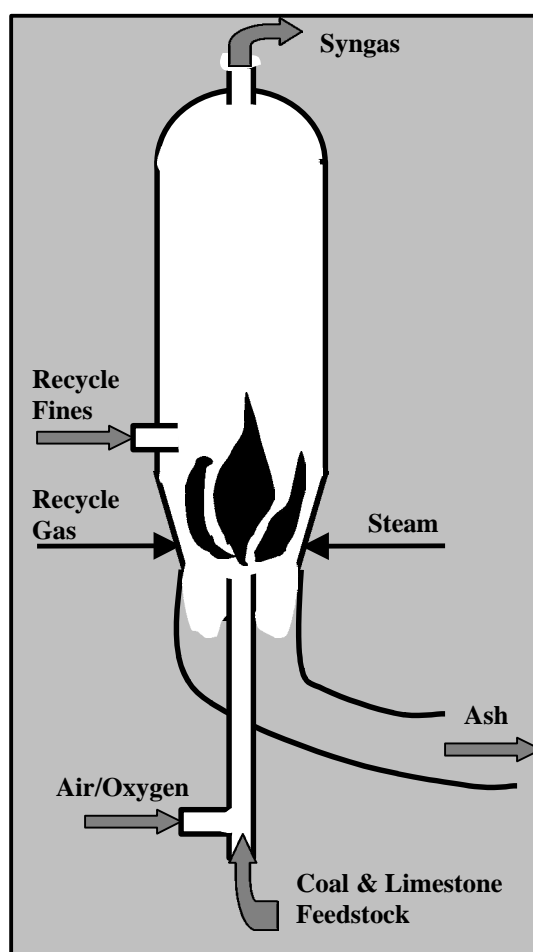

conversion of even small particles of coal in the feed. The velocity of gases in the reactor is selected to maintain most of the particles in the bed. The smaller particles that are carried out of the gasifier are recaptured in a high efficiency cyclone and returned to the conical section of the gasifier, where they again pass again through the jet flame. Eventually, most of the smaller particles agglomerate as they become richer in ash and gravitate to the bottom of the gasifier. Since the ash and spent sorbent particles are substantially denser than the coal feed, they settle to the bottom of the gasifier, where they are cooled by a counter-flowing stream of recycled gas. This both cools and classifies the material, sending lighter particles containing char back up into the gasifier jet. The char, ash, and spent sorbent from the bottom of the gasifier flow to the fluid-bed sulfator, where both char and calcium sulfide are oxidized. The CaS forms CaSO₄, which is chemically inert and can be disposed of in a landfill. Most of the spent sorbent from the gasifier contains unreacted CaO. Sulfur released from burning residual char in the sulfator is also converted to CaSO₄. Pinon Pine in Nevada (USA), is the only large-scale coal-based IGCC plant (100 MWe) which is using the KRW technology and it is also the only one which was designed with a 100% hot gas cleanup. The demonstration plant, owned by Sierra Pacific Resources and sponsored by the US DOE has had numerous problems. The gasifier had 18 start-ups and all of them failed due to equipment design. Successes in the project included operation of the combined cycle portion of the plant at 98% availability, efficient removal by the hot gas filter of particulates from the syngas and production of a good quality syngas for only 30 hours since the first syngas was produced in 1998. Sierra Pacific Resources, which owns the Pinon Pine power plant, was going to be sold to WPS Power Development but the sale has been suspended by the state of Nevada, which placed a moratorium on the sale of power plants in the state.

ABGC: The ABGC (Air Blown Gasification Cycle) is a hybrid system, which was developed at pilot scale (0.5 t/h coal capacity) by the former Coal Technology Development Division of British Coal. The gasifier is based on a spouted bed design and is operated at pressures up to 2.5 MPa and a temperature between 900-1000°C. Coal fed in the gasifier produces a gas with a low calorific value (CV) of around 3.6 MJ/m³. Sorbents, such as limestone are also injected into the gasifier to retain up to 95% of the sulfur originally present in coal. Syngas is first cleaned in a cyclone, then cooled to around 400°C and cleaned by a ceramic filter to be finally burned and expanded through a gas turbine. Only 70 to 80% of the fuel is gasified and partially gasified char and other solid residues (fly-ash and sulphided sorbent residues) produced in the gasifier are then transferred to an atmospheric pressure circulating fluidized bed combustor (CFBC) operating at a temperature of about 1000°C. Heat generated by the combustion of the char supplies a steam cycle used to drive a steam turbine to supplement the electricity generation. The ABGC process is forecast to have an efficiency of about 46-48%. The ABGC technology was later purchased by Mitsui Babcock Energy Limited (MBEL) which produced in collaboration with GEC Alsthom and Scottish Power PLC a design of a demonstration plant while being supported by the European Commission under the THERMIE program. A wide range of UK coals and international steam coals were studied for use in the ABGC. A laboratory at Imperial College of Science Technology and Medicine in London (UK), studied the impact of several coal characteristics on the gasification reactivity of some international traded coals in bench scale reactors that

could mimic the behavior of single coal particles in the ABGC. Coal characteristics studied included coal maceral composition and coal mineral matter composition.

BHEL: A 168 t/d coal capacity air blown pressurized fluidized bed gasifier IGCC pilot plant (6.2 MWe) was built at Hyderabad, India following previous gasification tests in a 18 t/d coal capacity IGCC fluidized bed gasifier pilot plant and in a 150 t/d coal fixed-bed IGCC pilot plant. The plant consists of a refractory lined reactor with a 1.4 m inside diameter in the bed, expanding to a 2 m inside diameter at the upper section of the gasifier. Crushed coal (6 mm size or below) is injected into the system via a lock hopper and a rotary coal feeder and then pneumatically transported into the gasifier with a portion of the air used by the plant. The dry granular ash produced during gasification is withdrawn from the bottom of the gasifier through a water-cooled screw extractor and is discharged periodically through an ash lock system. Three refractory cyclones operating in series are used for primary gas cleaning. Fines collected in the first two cyclones can be recycled in the gasifier but there is also the possibility to collect the cyclone fines, without recycling, through a lock hopper. The gasifier operates at a temperature of 1000°C and pressure of 1.3 MPa to generate a coal gas with a net calorific value of 9.8 MJ/kg. The 168 t/d coal demonstration plant was commissioned in 1996 and has since undergone a series of tests in stand alone and in IGCC mode, operating for a total of 1200 hours until the year 2000. The plant is designed for the gasification of Indian coals with a high ash content of up to 42%.

Transport Reactor: The Kellogg Transport Gasifier is a circulating-bed reactor concept that uses finely pulverized coal and limestone. The gasifier is currently in development, which may lead to a commercial design. It is expected that the small particle size of the coal and limestone will result in a high level of sulfur capture. Additionally, the small particle size will increase the throughput compared to a KRW gasifier, thereby potentially reducing the required number of gasifier trains (or the gasifier size) and the cost. The Transport Gasifier

is conceptually envisioned as consisting of a mixing zone, a riser, cyclones, a standpipe, and a non-mechanical valve. Oxidant and steam are introduced at the bottom of the gasifier in the mixing zone. Coal and limestone are introduced in the upper section of the mixing zone. The top section of the gasifier discharges into the disengager or primary cyclone. The cyclone is connected to the standpipe, which discharges the solids at the

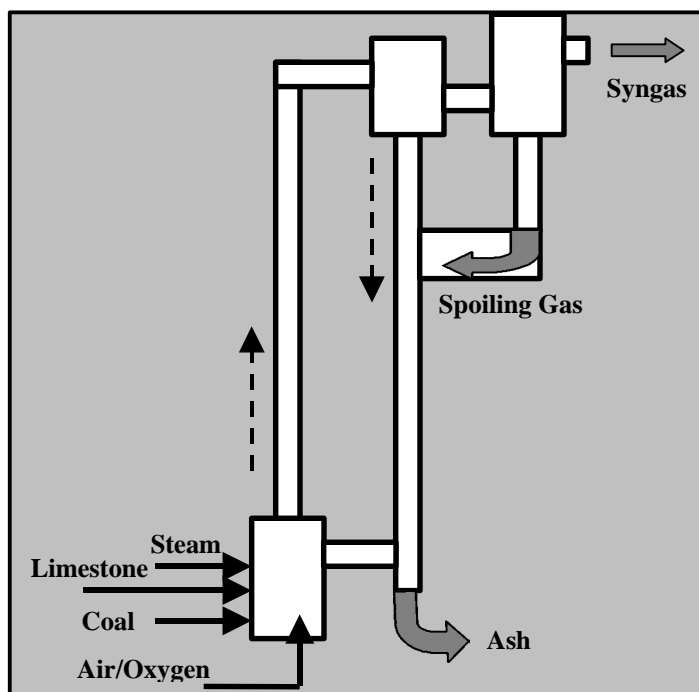

bottom through a non-mechanical valve into the transport gasifier mixing zone at the bottom of the riser. The gasifier system operates by circulating the entrained solids up through the gasifier riser, through the cyclone, and down through the standpipe. The solids reenter the gasifier mixing zone through the non-mechanical valve. The steam and oxidant jets provide the motive force to maintain the bed in circulation and oxidize the char as it enters the gasifier mixing zone. The hot gases react with coal/char in the mixing zone and riser to produce gasification products. The gas and entrained solids leaving the primary cyclone pass through the secondary cyclone to provide final de-entrainment of the solids from the gas. The solids separated in the secondary cyclone fall through the dipleg into the standpipe. A solids purge stream is withdrawn from the standpipe for solids inventory maintenance. The gas leaving the secondary cyclone passes through a gas cooler, which reduces the gas temperature from about 1900°F to 1100°F.

Fixed or Moving Bed Technologies

BGL: The British Gas/Lurgi coal gasifier is a dry-feed, pressurized, fixed-bed, slagging gasifier. The reactor vessel is water cooled and refractory lined. Each gasifier is provided with a motor-driven coal distributor/mixer to stir and evenly distribute the incoming coal mixture. Oxygen and steam are introduced into the gasifier vessel through sidewall-mounted tuyeres (lances) at the elevation where combustion and slag formation occur. The coal mixture (coarse coal, fines, briquettes, and flux), which is introduced at the top of the gasifier via a lock hopper system gradually descends through several process zones. Coal at the top of the bed is dried and devolatilized. The descending coal is transformed into char, and then passes into the gasification (reaction) zone. Below this zone, any remaining carbon is oxidized, and the ash content of the coal is liquified, forming slag. Slag is withdrawn from the slag pool by means of an opening in the hearth plate at the bottom of the gasifier vessel. The slag flows downward into a quench chamber and lock hopper in series. The pressure differential between the quench chamber and gasifier regulates the flow of slag between the two vessels. Product gas exits the gasifier at approximately 1050°F through an opening near the top of the gasifier vessel and passes into a water quench vessel and a boiler feed water (BFW) preheater designed to lower the temperature to approximately 300°F. Entrained solids and soluble compounds mixed with the exiting liquid are sent to a gas-liquor separation unit. Soluble hydrocarbons, such as tars, oils, and naphtha are recovered from the aqueous liquor and recycled to the top of the gasifier and/or reinjected at the tuyeres.

Lurgi: The Lurgi dry ash gasifier is a pressurized, dry ash, moving-bed gasifier. Sized coal enters the top of the gasifier through a lock hopper and moves down through the bed. Steam and oxygen enter at the bottom and react with the coal as the gases move up the bed. Ash is removed at the bottom of the gasifier by a rotating grate and lock hopper. The countercurrent operation results in a temperature drop in the reactor. Temperatures in the combustion zone near the bottom of the gasifier are in the range of 2000°F, whereas gas temperatures in the drying and devolatilization zone near the top are approximately 500-1000°F. The raw gas is quenched with recycle water to condense tar. A water jacket cools the gasifier vessel and generates part of the steam to the gasifier. Sufficient steam is

injected to the bottom of the gasifier to keep the temperature below the melting temperature of ash.

BHEL: The gasification media, a mixture of air and steam, is fed through a grate, which also enables ash removal. A gas cooler is used to recover part of the sensible heat of the gas produced and superheat steam for the gasifier. Further gas cooling as well as tar condensation are done by water quenching. Particulates are removed with a Venturi scrubber. A pilot plant has been operated for more than 5500 hours (1100 hours as IGCC) with two types of coals having high ash contents, Singareni coal with an ash content of 27-35% and North Karanpura coal with an ash content of 40%. The North Karanpura coal was also tested in the Lurgi pilot-scale plant at IICT under the same gasification conditions. It resulted in a better performance of the BHEL gasifier (calorific value and cold gas efficiency) due mainly to the larger scale of the gasifier. However the availability of the plant was affected by the poor performance of the raw gas cooler due to tar deposition and choking. A direct contact quench was subsequently designed to replace the gas cooler and overcome that problem. The performance of the moving bed gasifier was also compared to that of a pressurized fluidized bed gasifier later developed by BHEL at the Trichy unit in Hybedarad in India. Moving bed gasifiers produce tar-laden gas, which make the recovery of the sensible heat of the raw gas difficult. They also need coals with a certain particle size (5-30 mm). They produce large effluents containing tars and phenolic acids requiring elaborate effluent treatment. For these reasons, BHEL decided to develop the fluidized bed technology for the processing of Indian coals. A 6.2 MWe IGCC plant was developed by BHEL at the Trichy unit in Indian in 1988, as part of a research program for the development of gasification of Indian coals for the production of electricity. The gasification process was based on a moving bed technology developed in-house after experience on a Lurgi dry ash bed gasifier (pilot-scale 24 t/d) was gained at the Indian Institute of Chemical Engineering (IICT) at Hyderabad and at CFRI at Dhanbad. The gasifier is a 2.7 m diameter, 14 m high jacketed moving bed gasifier with a coal throughput of 150 t/d. Crushed coal of 5-40 mm size with an ash content of about 35% is the design feedstock for the gasifier, which is operating at 1 MPa pressure.