

# **From the Preface of “The Heart of the Engine”**

In the winter of 1969, I traveled to Europe for the first time. Everything I saw and heard was fresh and marvelous to me. This awe was because at that time the direct-injection diesel engine was still in its infancy in Japan, and I was shocked by our significant lag in technological development as compared to Europe. I took the opportunity one day to visit the German museum, and I was astonished to see the aircraft engine made by Benz in 1910. This amazement was because of the way that Benz had mounted the oil pump to the aircraft engine. During the summer of 1966, I had been working to resolve an unexplained power loss in Hino's racing car HINO-PROTO each time it was tested on the Fuji Speedway. After much effort and hard work, I determined that the oil pump was causing the power losses. Again, after much effort, I found a solution to the problem. Fortunately, the HINOPROTO won the next race. What had amazed me was that my innovative solution had already been used on that old engine originally made in 1910. I was again surprised in the museum of the Mahle Piston Company, my next destination. I found that my invention for reducing oil consumption, which I believed was applicable to any engine, had been rather casually exhibited as an example of a particular solution that had been arrived at half a century ago.

This is how my interest in museum visiting began. From my experience with museums, I began to understand that it is occasionally necessary to look down and observe the river of technology instead of always struggling in its currents.

When one stands on a bridge, he can see upstream and predict the direction of the stream flow. Similarly, each significant accomplishment in the past offers, to those who can see, clues and suggestions as to how we may overcome the technological challenges we face today. In this book, I have gathered those suggestions and clues offered by history that impressed me, in the hope that they will guide and inspire those who labor everyday to improve technology.

Some people believe that our civilization based on mobility is close to its end because it has become too immense to function properly. They may also believe that, because of excessive automation, modern technology has reached a critical juncture. Many people do not realize that technologies as advanced and seemingly remote as rockets and nuclear power are actually close to them. Having traveled the journey of the internal-combustion engine, I have learned that technology stems from the simple wish to improve human life. Because of this basic desire, one cannot help but find an unlimited sense of humanity within each advance in history of technology.

More than 100 years have passed since the invention of the internal-combustion engine. But even today this engine is at the leading edge of technological advancement, along with the automobile. The reason for this is simply that the engine has become more and more closely tied to human life.

With the worldwide concern over the depletion of energy sources and environmental pollution, the technological improvements that can be made on the engine and the automobile are limitless. Thus, automotive engineers who can merge modern technologies with humanism are indeed fortunate. I am one of those people who envisage the future continuously improving, thanks to the efforts of the innovator and the engineer.

**Takashi Suzuki**  
**August 1980**

## **Carnot's Excellent Idea**

Because it was widely used during his time, Carnot studied the steam engine. He was surprised to find that, with steam as the medium, there were boundaries to the differences in the highest and lowest temperatures. Based on this finding, Carnot explained that he would need to build an engine that compressed the air it used before ignition. Carnot's work later provided the basis for the internal-combustion engine. In addition, Carnot predicted the eventual demise of steam locomotives, which happened only a few decades ago (Photo 9-1). This demise is natural since a steam locomotive can convert to useful work only about 10% of the fuel energy supplied; the remaining 90% is wasted. Surprisingly, the steam engine has outlived just about any other kind of engine. Attempts to use the steam engine for aircraft were made as late as 1933. Even in recent years, the use of the steam engine in the automobile has been considered as a possible answer to the internal-combustion engine's noxious exhaust emissions problem (see Appendix A15-1).

Carnot's publications reveal another surprising fact. He listed many of the desirable attributes of the engine in much the same order as we do today, that is, fuel consumption, reliability, lifespan, size (weight), and cost.

Carnot was reported to have said,

“Through proper evaluation on the convenience of an engine and the realizable economy, it is necessary to distinguish the primary factors from the secondary ones, and to keep the primary factors in balance so that the best result is achievable by the simplest method. Development personnel should satisfy this requirement and should lead the work done by the related divisions and subordinates so that all staffmembers cooperate to achieve the goal.”<sup>(9-2)</sup>

In effect, Carnot described an engine development group as it functions today. As an automotive engineer, I was relieved to note that even a genius such as Carnot did not concern himself with air pollution due to exhaust gas. As a result, he has fewer evaluation items than we have today. As I read

through Carnot's book, I was surprised to learn that Carnot had carefully organized and used efficiently the experimental results obtained by earlier workers such as J. Gay-Lussac and J. Dolton. This review of earlier work shows that even a genius cannot have an idea just by daydreaming. This book is impressive among those written in his century. From it, we can learn a basic rule: When working to solve a problem, we should study and review the results obtained by earlier workers in the field, organize the data, and then make our decision. If we just sit in a quiet room to think without studying earlier work, then only the Sandman will come rather than a new idea.

## Writing Between Military Services

According to his biography, Carnot had been drafted into Napoleon's army as a student soldier when he was a student of Ecole Polytechnique. He later served in the military again and was discharged in 1828. His book was published in 1824, so it must have been written between his stints in the military. I admire Carnot for his positive attitude in understanding and solving his technological problems even under the adverse conditions of an army at war (Fig. 9-2). His theory remained obscure for a long time, finally receiving recognition after it was analyzed, edited, and published by his schoolmate, E. Clapeyron, and still later by William Thomson. This instance shows the importance of making sure people fully understand one's thoughts or concepts before asking them to accept it. This understanding by one's peers will be particularly difficult if the ideas are beyond the accepted realm of thought.

As an aside, it was said that when Carnot was a science student, his classmates teasingly said that the symbol for entropy,  $S$ , was taken from the initial letter  $S$  of Carnot's first name, Sadi.<sup>(9-3)</sup>

Finally, I would like to introduce a thought that was among those written by Carnot. The question asked by Carnot was, "If God is the source of ultimate good, then why does He punish sinners for all eternity?" In the 12th Century book *Tannisho*, the famous Japanese Buddhist monk Shinran said, "Even a happy, good man can go to heaven. Then, why not a bad man who has had a bitter experience in this world?" Carnot, a genius who died of cholera at the age of 36, may have gone to heaven to determine the answer to the Shinran's question for himself.

The average lifetime of a European at the beginning of the 19th Century was about 30 years. Carnot cannot be said to have died at an early age. Since his time, the human lifespan has been extended considerably. Major

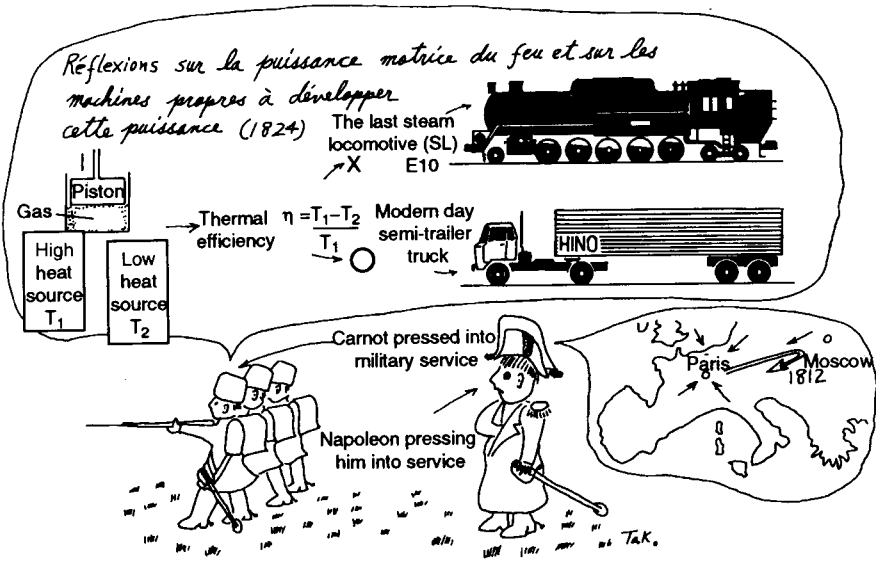

Fig. 9-2 Carnot participated in the 1814 battle in Vincennes. He was discharged from the military in 1828.

factors in extending the human lifespan include Jenner's discovery of the smallpox vaccination<sup>(9-4)</sup> and the improved quality of life due to the Industrial Revolution. As indicated earlier, the invention of the engine set off the Industrial Revolution, which served as one of the triggers for extending the lifespan of man.

**Note:** One day in 1979, I visited the Ecole Polytechnique, where Carnot had studied, to honor his achievement. To my disappointment, the gate was barred to visitors. A young man leaving the facilities said, "This is now a military school. The present Ecole Polytechnique is located in a suburb of Paris" (Photo 9-2).

relation as the dark side of scientific technology and described it as follows: “War is an instinctive ‘karma’ of mankind. Technology is a most powerful collaborator in wars and sometimes may become a prime mover....Science seeks truth and places ‘human love’ at the center. I am amazed at how easily science can expose its dark side.”<sup>(4-1)</sup> Fortunately, Japan has been able to avoid war for a long time. Not only engineers, but people in general, should always recognize and confront the “karma” of mankind.

I have strayed from my subject. Mr. Kamo is not a war-loving person, but rather an engineer who has devoted himself to conserving energy. He is also a humanist who enjoys growing radishes in his garden after he comes home each day. Mr. Kamo’s garden covers more than an acre (4047 m<sup>2</sup>) in his back yard. He even bought a used tractor to cultivate his radish field (Photo 10-2). Even after his mandatory retirement from Cummins Engine Company, Kamo has dreamed about the adiabatic engine. He established a company called Adiabatics, Inc., and has continued his research (Photo 10-3).

## **Idea of Double Expansion**

Englishmen Jonathan Hornblower and Arthur Woolf thought of the double expansion process in 1781, five years after Watt completed his steam engine. Ironically, Watt sued the two men for patent infringement. Hornblower and Woolf lost their case because they were unable to properly explain their double expansion theory to the court.<sup>(12-1)</sup> Making people understand a new idea objectively is difficult, but it is necessary for the future development of technology. In 1845, William McNaught completed a steam engine that was dependent on double expansion after he improved Hornblower's design.

For the reader's information, the first Japanese-made steam locomotive completed in 1893 was dependent on this double expansion concept. The engine was supervised in its construction by the brothers F.H. and R.F. Trevithick, grandchildren of Richard Trevithick, the steam locomotive inventor. I understand that this double expansion steam locomotive was 20% more economical than its preceding single expansion type<sup>(12-2)</sup> (Photo 12-2). Now that the double expansion engine is a reality, it is natural to think that a triple expansion engine would be feasible. In fact, the triple expansion concept has been put into practical use as a steam engine. Even though this engine is said to have been first manufactured by the German company, Ferdinand Schichau, in 1883, an actual example has been preserved at the Massachusetts Institute of Technology. This engine is the Troy engine manufactured in 1909. According to historical records, this type of triple expansion engine was used in many ships (Photo 12-3).

The P40 conversion to a large output engine was finished in 1941, while the P51 design had been completed in 1940, a year earlier. At this time, the Curtiss Company should have re-examined the superb design of the North American plane. It may be pointed out first that the Curtiss project team failed to keep up with the state of the art, and the team also lacked a firm direction in the design. It appeared that the team had no focused company goals or objectives, and it lacked conviction and determination. The engineering staff lacked a spirit of innovation, and they were afraid to take risks. These shortcomings contributed to the final decline of the Curtiss aircraft company.

The Bradley Air Museum in Connecticut exhibits a strange-shaped aircraft with a front-mounted piston engine powering a propeller and a jet engine under the fuselage. Its sign reads, "The last aircraft made by Curtiss in 1945." After a long vacillation as to whether the jet engine or the piston engine would be used in the future, company officials decided not to decide, instead mounting both engines on a single plane. This lack of decisiveness was another step in the fatal decline of this once prosperous and innovative company (Photo 13-3).



A design that lacks intuition can be considered poor work. This sense of intuition cannot flow if everyone in the group remains silent. Intuition is not something found in reference books. Only when the problem is struggled with repeatedly for a long time will intuition finally surface. The excellence of a design supported by careful thought and adequate consideration will be obvious to the observer.

A new design calls for an adventurous spirit and the willingness to take chances. However, when going on an adventure, contingencies should always be provided should the adventure fail. A development procedure must have some goals from the very beginning, and these goals should be incorporated into the management policy. A flaw in the basic policy such as hastily subcontracting a vital component of the war effort to the enemy was one factor that helped to defeat a country. This catastrophe was not a failure of engineering; rather it was a failure in engineering management. The engine nacelle with its engine compartment design that contributed to the defeat of the Third Reich is now resting quietly in the Smithsonian Museum. However, its sleek, compact form appears incapable of housing a huge V12  $\times$  2 engine (Photo 18-4).

In a post-war test by the U.S. military, this plane reached a maximum speed of 695 km/h. The high-performance capabilities of this plane can be seen from the extremely thin fuselage and the large-diameter propeller (Fig. 18-5). Although a variety of factors contributed to its success, the configuration of its main wings appears to have made the most significant contribution. One of the *Saiun* designers, Mr. Yasuo Naito, had statistically studied the characteristic values of as many as 300 airfoils that had been evaluated at the U.S. NACA in a study of the wing shape as a parameter. As a result of this analysis, a new laminar airfoil (airfoil with reduced resistance for use in a high-speed plane) was designed and adopted for the *Saiun*. It was reported that his firm did not have the high-speed test facilities necessary to test this new airfoil, so tests were performed in a high-speed wind tunnel at the Japanese Naval Aeronautical Engineering Center. The general plan of the *Saiun* was approved by the military in July 1942, the issuance of drawings began in September, and by December it was 90% completed. The maiden flight was May 15, 1943. These engineers had always been keeping up with technological advancements by reading pertinent technical journals and studying experimental data with enthusiasm and with tightly defined objectives. The dedication of these engineers paid off in the successful completion of this urgent project. This notable and rapid development is an event that every engineer should remember and compare to the poor P75 developmental efforts that used the 1930s P40 airfoil just because of an immediate need for the aircraft.<sup>(18-2)</sup>

## **Chadwick's Extraordinary Talent**

The *Manchester* twin-engine bomber made its debut on February 24, 1941, in the Royal Air Force attack on Brest, Germany. On February 27, only three days later, an improved model with four Rolls-Royce engines of the usual V 12- cylinder configuration made its test flight. Chadwick had obviously been preparing a backup from the very beginning of his project. Surprisingly, though, he had also been planning a transport plane version of the bomber in parallel with the *Lancaster*. The transport plane, called the Avro *Yoke*, played a prominent role in transporting soldiers and weaponry. Transport is indispensable in wartime. Even though many bombers were hastily converted to transport airplanes during the war, the British Avro manufactured both bombers and transport airplanes from the same production line

with an ample time margin. Thus, the *Manchester* twin-engine bomber was discontinued after only 159 units. The four-engine *Lancaster* was produced from the same assembly line as the *Manchester* and sent to the battle front in a steady stream.<sup>(19-1)</sup> I cannot help but admire Chadwick for his design philosophy, his engineering management, and his leadership. As a result of all these traits, the *Lancaster* sits proudly in a place of honor in the museum.

evade the enemy bullets. Christie, however, envisaged that future tank battles would be like the German-Soviet confrontation on the Soviet plain or the German-American/English tank battles in North Africa. His ideas were not those of an ordinary person. For comparison, the Japanese 89-type tank used in the Nomonhan (Battle of the River Khalkin) had a maximum speed of less than 26 km/h.

No one at the time appreciated Christie's concept of speed except for the Soviet Union. In 1931, the Soviet government purchased two of Christie's 10-ton tanks under the pretext of that they were agricultural tractors. The Soviets then duplicated these tractors, modified them into military tanks, and transported these tanks to Nomonhan. The only way the Japanese could retaliate against the new tanks was by using Molotov cocktails or fire bombs.

The duplication of the Christie tank and further development was carried out by Mikhail Koshkin. Immediately after the battle at Nomonhan, Koshkin replaced the gasoline engine with the diesel engine so as to reduce the hazard of fire with gasoline fuel. This modified tank was later developed into the T34 tank, which has been called the best tank of World War II (Photo 25-1).

## **Appearance of the T34 Tank**

In July 1941, five months before the Pearl Harbor attack, the German armored corps on the eastern front was terrified at the sudden appearance of the T34 tanks. Douglas Orgill, in his book<sup>(25-1)</sup>, recalled, “One Soviet tank suddenly came out of the cornfield. It had a strange crouching shape. Immediately, several German army tanks fired at it, but without much success. The tank began maneuvering along a road between fields. At the end of that farm road, a German 37-mm antitank cannon was waiting for the tank. It began to rain shells on the approaching Soviet tank. The Soviet tank, unharmed, kept going into the German-held territory, crushing the antitank gun underneath its broad tracks.” (See Photo 25-2.) The T34 tank, which thus appeared in the Russo-Germany war, did not burn when hit as easily as those tanks equipped with gasoline engines. Also, because the T34 tank had low fuel consumption, it could travel three to four times the distance of its German counterpart. Making use of its high speed, the T34 tank moved quickly on the Russian plains and eventually led the Soviet Union to victory.

Lessons learned from the battle at Nomonhan, data from mechanized unit experiments, and practices evolved from those in England since 1927 were all carefully assimilated into the Soviet tank. Original analysis and research



were also performed. The key points were to strengthen both the antitank firepower and the tank's armor.

Fig. 25-1 compares an increase in the thickness of armor plate between Germany and Soviet Union, both countries leading the world in tank production at that time. From this figure, we can see that the Soviet tank quality was progressing faster than that of Germany. The figure is also impressive in view of the Soviet history. The so-called great purge in the Red Army continued from 1937 to 1939, during which time high-ranking and foresighted officers such as General Tukhachevsky were all dismissed or executed. During this period, Koshkin and his team continued to improve tank technology. When the purge was over, they had developed the new T34 tank. This purge is said to have been ordered by Stalin, who labeled the "tankman sitting in an iron box and looking down on the general public as a tool of imperialism and bourgeoisism afraid of the proletariat's power."<sup>(25-2)</sup>

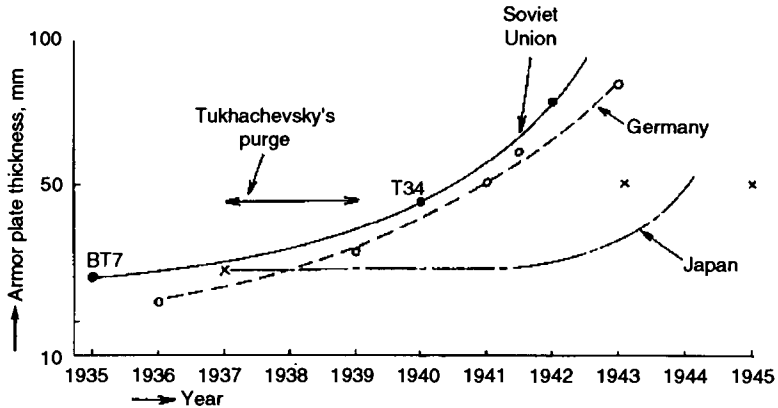

Fig. 25-1 Increase in thickness of armor plate for medium-size tank.

## Difference Between the Russian and Japanese Engineering Staffs

The design of the diesel engine in the T34 tank is commonly credited to J. Vikhman and T. Chupakhin. However, this engine was in fact a copy of the Fiat aeroengine. Nevertheless, the improvements made on the T34 tank were the result of studies from Christie's excellent design; lessons learned from the battlefield (market need in today's terminology) were taken into the design immediately; and the competitors' designs were examined and dexterously combined (benchmark activity) to complete the final product, as illustrated in Fig. 25-2. This process should be learned by every designer.

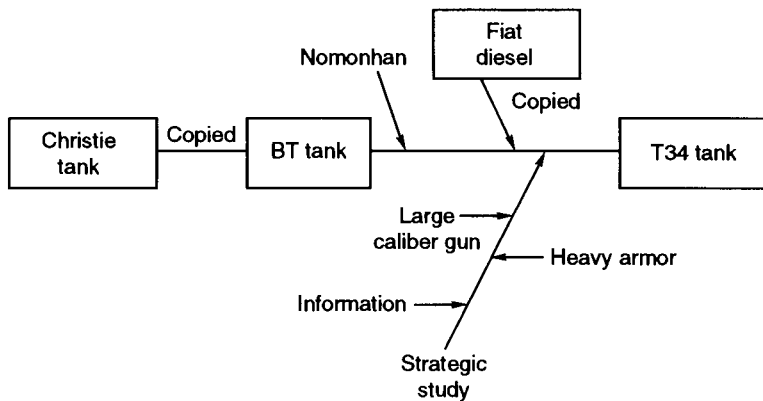

Fig. 25-2 Process of T34 tank development.

The author of *T34 Tank*, D. Orgill, comments, “The T34 was born of people who could visualize the battlefield of the 20th Century [market trend at present]. They were not geniuses but ordinary people. The T34 was the product of normal people with foresight.”<sup>(25-2)</sup>

Let us look at Fig. 25-2 again. What a miserable situation the Japanese tanks were in! In contrast with the Soviet Union, which rapidly learned from the Battle of Nomonhan (the River Khalkin), the Japanese military failed to learn anything from the battle and reactions were slow. Mr. Kohtaro Katogawa, who was associated with the Japanese army tank development and knew the exact situation at that time, explained: “The military staff did not have much understanding of tank operation; partly because there was no one who dared to lead or champion it, weaponry study did not progress significantly as it was influenced by the China Incident, which had no anti-tank battles.” He added with disappointment, “The improvement of the 75-mm tank cannon was incredibly slow, taking a full five years.”<sup>(25-2)</sup>

In spite of the Japanese Army’s having no political purge such as did the Soviet army, the Japanese tank research work slowed to a halt. On the other hand, the Russian research activities continued in spite of the hardships imposed by the political purge. These reactions show the differences in the commitment of the Japanese and Soviet engineering staff. The difference in devotion and positive thinking for research work between the Soviet Union and Japan resulted in a large technology gap.

## **Appendix A26 B2 (or V2) Diesel Engine for T34 Tank**

The B2 diesel engine was composed of aluminum alloy and had a direct injection system with 60° V12 cylinders, overhead camshafts, 150-mm bore, 180-mm stroke on main connecting rod side, and 186.7-mm stroke on sub-connecting rod side. The subconnecting rod layout is shown in Fig A26-1. This diesel engine had a 38.8-L displacement and four valves with the fuel injection nozzle in the center of the cylinder and had a capability of producing 500 hp/1800 rpm, a maximum engine speed of 2000 rpm, and an output per displacement of 12.9 hp/liter. To my surprise, the fuel consumption was only about 170 g/PS-h. The Japanese diesel engine could not obtain this level before the 1970s. The water and oil pumps were positioned at the lowest level, so we can see attempts to minimize problems resulting from inadequate oil supply.

In contrast, the Japanese Type 100 diesel engine at that time was of a pre-combustion chamber design. Although details are unconfirmed, its fuel consumption was estimated to be above 200 g/PS-h. The Type 100 engine had the following specifications; 120-mm bore, 160-mm stroke, and 120-hp (11 hp/liter) with six cylinders. The largest engine in this series was a super-charged V12 (in trial manufacture) that delivered 300 hp.<sup>(26-5)</sup> However, it is

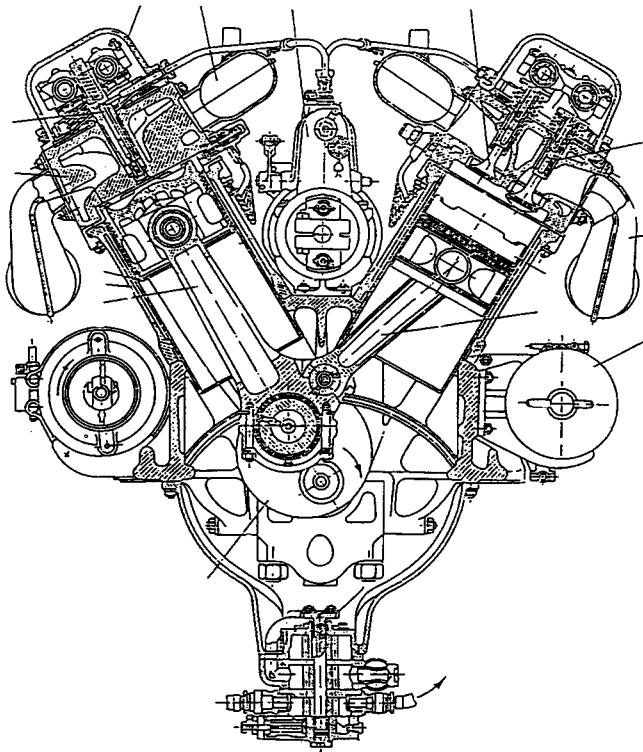

*Fig. A26-1 B2 (V2) diesel engine: Oil and water pumps are located at the lower end of the engine. The designers were thinking of the survival of the engine even with battle damage or under extreme operating conditions (or to withstand abuse). However, the subconnecting rod system, direct-operated valve gear (intake/exhaust valves directly driven by camshaft), etc., are quite the same as those of the Fiat gasoline aeroengine.*

worth mentioning that this diesel engine was air-cooled. In particular, the suction-type cooling from the prechamber side (port side), which was high in thermal load, was an excellent arrangement (Photo 26-4).

## **Product Value Increased by Technology Fulfilling the Users' Needs**

What were those radial engines that flashed across the sky and then disappeared like meteors? Were they on the right technological path or were they mere technical trials or experiments? Did they merely want to display their dazzling or fantastic characteristic as merchandise?

Every product should be designed and engineered to meet the users' needs. Consumers may sometimes purchase products that deviate from the right path technically; however, if this deviation is excessive, then these products will soon disappear. Thus, when an engineer designs a new product, it is important that the amount of deviation from the commonly accepted trend be determined so that the product's lifetime can be projected. It is necessary always to be aware of the right path so as to prepare for the next product cycle.

In August, three months after Lindbergh's successful May 21, 1927, flight that crossed the Atlantic, the Packard Company completed a license agreement with Hermann I.A. Dorner, a solid-fuel injection diesel engine researcher then living in Hanover, Germany. Thus, the Packard diesel engine was to be based on the Dorner unit injector (detailed later) fuel injection system.

The new engine strived for the same output and weight characteristics as the Wright "Whirlwind." After only one year, or on September 19, 1928, Packard succeeded in the first flight with this engine mounted on a Stinson-Detroit plane (Photos 32-1 and 32-2). Then, in May 1929, the plane crossed the American continent in 6.5 hours, demonstrating that the fuel cost for this flight was only \$4.68, about one-fifth of the fuel cost for a gasoline engine. The next year, 1930, the Packard Company began its commercial-based production. On May 25, 1931, the *Bellanca* monoplane mounting the Packard diesel engine took off from Jacksonville, Florida, to challenge the endurance flight record. This plane flew for three days and established a new world endurance flight record of 84 hours and 33 minutes. Further, in 1932, this engine was mounted in the Goodyear airship, which made a world altitude record with the use of a diesel engine. These successes attracted worldwide attention.

For example, the engine was manufactured by Walter in Czechoslovakia as the Walter Packard diesel engine. On March 31, 1932, U.S. President Herbert Hoover awarded the Robert J. Collier Trophy to the Packard Motor Car Company as the outstanding performer in the aeronautical field. The award ceremony was held at the White House with high officials from U.S. Department of Commerce and other agencies in attendance. Among the attendees was Amelia Earhart, a woman pilot who later disappeared mysteriously above the Pacific while piloting the Lockheed Electra for the round-the-world flight. During the award ceremony, President Hoover highly praised the Packard engine, stating that it was an unprecedented pioneering job (Photo 32-3).

Everyone believed that this engineering project was a brilliant success. The following year, 1933, however, this diesel engine project was abandoned, which resulted in closing the new factory costing \$650,000 (a tremendous amount of money at that time) and terminating 600 newly employed



*Photo 33-3 Stinson plane mounting Packard diesel engine: The Stinson plane was painted black to make the soot staining due to exhaust gas from the Packard engine inconspicuous (Ford Museum).*

## Essence of Failure

Packard's technical failure was analyzed by Robert B. Meyer.<sup>(32-1)</sup> Based on his analysis, I would like to list the important factors according to my own opinion (refer to Appendix A33-1).

- (1) *Premature initiation of production for a new technology*—As we noted earlier, the diesel engine itself was still in its infancy. The direct injection system particularly required more research and evaluation before its production. It is well known today that a diesel engine emits a higher-density exhaust smoke at lower air densities (higher altitudes). A supercharger is indispensable when such an engine is used for airplanes. The more successful aero diesel engine Junkers had a supercharging system. Woolson himself was applying for a patent on the same invention. Thus, Packard's attempt to fly with a diesel engine was at least three years too early.
- (2) *Inadequate technology for the fuel injection system*—The fuel injection pressure was recorded as 70 atm. This value is extraordinarily low from today's viewpoint. The technology on not only the fuel injection system



but also diesel combustion itself was yet to be established. The completion of the direct injection technique in three years or so could not have been expected. Packard's greatest error may be its selection of Dornier as the partner in a technical tie-up, since his product had not been proven to be saleable. For an earlier completion of a product, the partner should have been selected from among those who had established technology. Even if such a partner had been selected, another three years might have been required to complete the project.

- (3) *Engine output too low*—While the Packard diesel had the same power rating as the Whirlwind engine for continuous operation, another important power rating for aircraft engines is the “Take-Off Power” rating. The engine must be run at this higher power level for only a few minutes before decreasing power. About the time of the introduction of the Packard diesel engine, oil refiners were able to increase the octane number of gasoline. Thus, gasoline engines such as the Whirlwind were able to increase their Take-Off Power rating without combustion knock. In other words, the Packard diesel's competition became immediately stronger. This experience shows that product developers should attempt to foresee the possible technological advances in competing products.
- (4) *Price too high*—The Whirlwind engine cost \$3000, while the Packard engine was sold at \$4025. Even this price difference of \$1025 might have been allowed if the diesel engine had not caused such strong vibration, heavy smoke, and odor remaining on clothes. The Packard car (Photo 33-4) was selling for as high as \$3250 at that time even though the Ford Model A automobile was selling for only \$511 (Photo 33-5). A product can be sold for any price if the buyers recognize the value in the merchandise as being worth the money.

Japan initiated an urgent effort to develop a similar boat, including the engine. No engine could be developed from scratch in such a short time period. So, the Mitsubishi Kinsei air-cooled radial aeroengine was used, and a few units were available for action in the final stages of the war. Needless to say, the problem of cooling the engine on a boat could not be solved as easily as it was in the air-cooled aeroengine. Consequently, this development project ended, leaving a meaningless fuss and an engineering officer's suicide.<sup>(34-1)</sup> Upon purchasing the torpedo boat from Italy, it was reported that the supplier asked the buyer, "Why don't you purchase several of these boats? Do you know we have had an order for many of these boats from England?" (Perhaps because of inadequate domestic supply?) If the source of this information had been determined, the effectiveness of the torpedo boat might have been more evident. If the Japanese Navy had acquired at least 20 of these boats, then perhaps Japan could have controlled the enemy's wild attacks in the Solomon Sea.

If the background and trend had been analyzed carefully, the Italian recommendation would have resulted in an order for 20 boats. However, the exact transmission of site information, proper background analysis, and cultivation of sharp sensitivity were important roles for the development division to play, which is the same as it is today.

## **Excessive Quality and Inadequate Quality Control**

The distinction between airplane production and automobile production (which may be said to be the same as the distinction between the defense and civilian industries) is one point to be considered. Post-war Packard was unable to make this distinction. Between the two industries, there are large technological differences in not only the design, but also in production engineering, that is, the finish accuracy. During the war, the Ford Motor Company attempted to manufacture the Pratt & Whitney aeroengine but failed

initially. After receiving full-fledged support from the Pratt & Whitney Company, Ford began to produce a satisfactory product.<sup>(34-3)</sup> In contrast, Packard Company was able to manufacture the Rolls-Royce Merlin engine without outside support. Unfortunately, this superb engineering talent had an effect opposite of what was intended. I wonder if Packard's planned production efforts had always suffered because the Packard vehicle had so many areas with higher quality than was really needed for a car.

The highest level of quality may not always be the most appropriate quality. It is necessary to incorporate the "proper quality" in any market that is undergoing change. The market does not reward excess quality. It only says, "Excellent." Although it may be necessary to stay one step ahead of the competition, there is no need to be ten steps ahead. Packard lost the proper balance between design engineering and production engineering/feedback of marketing information and between its marketing plan and marketing techniques.

In 1956, Packard recalled 5400 cars twice due to a defective rear axle. Further, because the rubber pad in the seat was considered too stiff, it was replaced on all cars without charge. This latter recall was a result of Packard's failure to provide proper guidance on quality control for an affiliated company. The company lost control of its actions. The compact and elegant style that had so impressed a young man (me) in an underdeveloped country (Japan) had turned into an alcoholic and profligate son (Photo 34-4). Its brilliant history suddenly came to an end. The Packard Company could not reverse its downward slide. Finally, the shell of the once proud company was acquired by an industrial engine manufacturer, D.W. Onan & Sons Inc., in 1961.

## **Appendix A36 Dyna Panhard Engine**

In the world's first speed race from Paris to Bordeaux to Paris in 1895, the Peugeot car, with the Daimler engine, claimed the victory. Actually, the Panhard & Levassor car had crossed the finish line 10 minutes earlier. However, the car had been disqualified because it had only two seats while four seats were required to compete. Since the race, however, Panhard Company had a number of successes and went on to dominate the European car market. After both Panhard and Levassor died, their company continued to produce only premium vehicles and gradually lagged behind companies that manufactured more popular cars.

At the end of World War II, this company attempted to regain its old dominance in a single stroke by putting the Dyna car on the market. The new vehicle was designed by J.A. Grégoire, who adopted the front-engine/front-drive (F-F) and developed an air-cooled, horizontally opposed 600 cm<sup>3</sup>, 28-hp engine. This new model became the Dyna Panhard via the Dynavia's trial as mentioned previously. The Dyna Panhard engine had 850 cm<sup>3</sup> displacement with 42 hp, but this power was eventually increased to 60 hp. The Dyna Panhard was a very ambitious undertaking with an aluminum body and unique engine. In addition to the previously mentioned connecting rod bearing, the tappet was made of aluminum. Moreover, the engine adopted an automatic hydraulic valve gap adjuster, used a single torsion bar as a valve spring for both the intake and exhaust valves, and utilized a needle bearing at the rotating end of the torsion bar. The engine was filled with

innovative ideas (Fig. A36-1). You can be sure that an engineer who saw this engine for the first time would have been awestruck by the design.

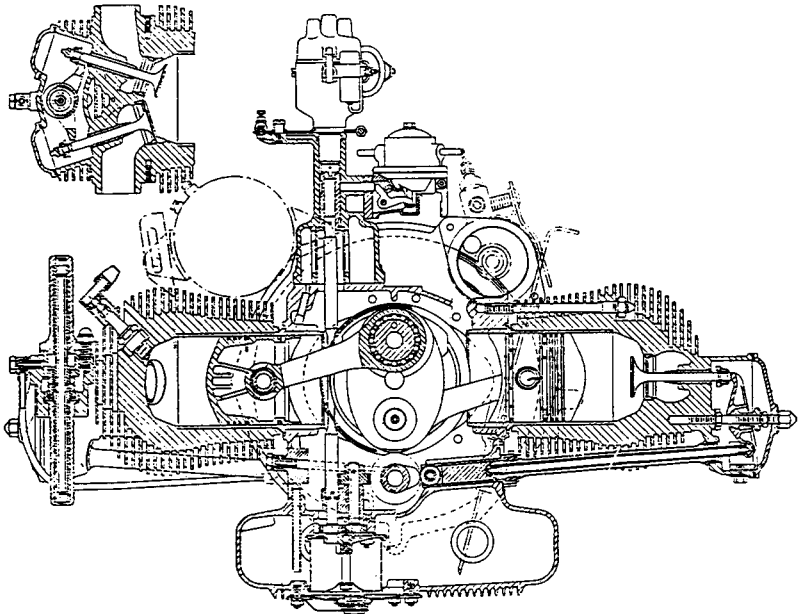

*Fig. A36-1 The Dyna Panhard engine: 85-mm bore, 75-mm stroke, 851-cm<sup>3</sup> displacement, 42 PS/5000 rpm (1958), power later expanded to 60 PS.*

However, a good impression does not always ensure a successful product. The Dyna Panhard was later absorbed into Citroën, and its unique engine soon disappeared.

## **Is the Use of Roller Bearings Appropriate?**

The use of roller bearings may have been appropriate by the German heavy industry: The German industrial machine had already accumulated sufficient production engineering and empirical knowledge to manufacture and support the incorporation of the roller bearings in its machines. However, roller bearings should not be used unless the infrastructure can support the stringent requirements. The trouble with the ABC engine, as pointed out by Professor Kiyoshi Tomizuka, occurred before roller bearings became widely used. I wonder if the problems with the ABC engine can be attributed to inadequate supporting conditions.

In 1964 and 1967, Honda produced 1.5L and 3L Grand Prix engines, respectively. Both engines incorporated roller bearings in their design. Using these engines, the Honda entry fared well in several races, stirring the blood of Japanese race car enthusiasts. I later heard that the engines had no problems with their crankshafts. When the design is exact and conditions for accurate machining are met, the results will meet our expectations. In conclusion, it can be said that the introduction of the DB600 series engines into Japan during World War II was too much of a technical burden for Japan's engineering level at that time.

When introducing new technology or challenging others for superiority, we should determine the difference of the new technology from that which already exists. Is the new technology merely an extension of existing

technology, or is it truly innovative? Does the new technology consist of an advancement of existing technology as well as a completely new idea? If so, to what degree? What field appears to be unknown? The answers to all these questions must be well categorized. Then for each category, those areas requiring preliminary research and study or those that are to be developed in parallel should be examined. Afterward, a development plan should be prepared.

If the proposed project has extensive missing knowledge, then the project should be either modified to use more of the known data or else courageously postponed until the boundaries of existing knowledge are expanded.

A person need not give in to an innovation thoughtlessly. He must determine if the bar in his high jump is within or beyond his ability to jump. After the challenge is accepted, then the distance and speed of the approach run should be carefully planned. This need for careful evaluation in a high jump is the same as that required for a technological jump.



arises as to why was an electric appliance company such as Philips would be studying such an old engine.

Before World War II, the Netherlands was eagerly surveying the resources in Borneo (Kalimantan), then a Netherlands colony. The explorers wanted a small portable generator to be used at campsites in the interior of the jungle. Their requirements were: “The engine for the power generator should be able to burn any fuel without emitting a noise, unlike a gasoline engine. Besides, if no sound is emitted, then people can sleep soundly and listen to the radio free from distractions. If such an engine can be made, it would be useful not only for resource surveying, but also for military service.”

A combination of the Stirling engine and a generator fit their need. Thus, since 1937, Philips' development project for a portable generator had been continued secretly despite the German Army occupation. Then, the project was forced to change its direction due to the flow of history, that is, the end of colonialism, and Philips' engineering was also inherited by the newly established United Stirling AB.

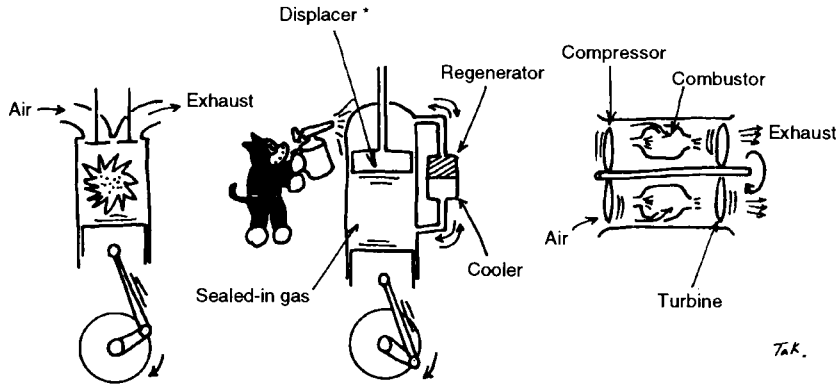

The reciprocating engine:  
Intermittent combustion  
in a cylinder

Stirling engine:  
Heating from outside  
of the cylinder

Gas turbine engine:  
Continuous combustion  
in the combustor

\*Displacer serves to control gas transport for expansion and contraction of the sealed-in gas and transmit an expanding force to the piston (reference is made to a cartoon character "Norakuro" of Suiho Tagawa).

*Fig. 39-1 Operating principles of reciprocating engine, Stirling engine, and gas turbine engine.*

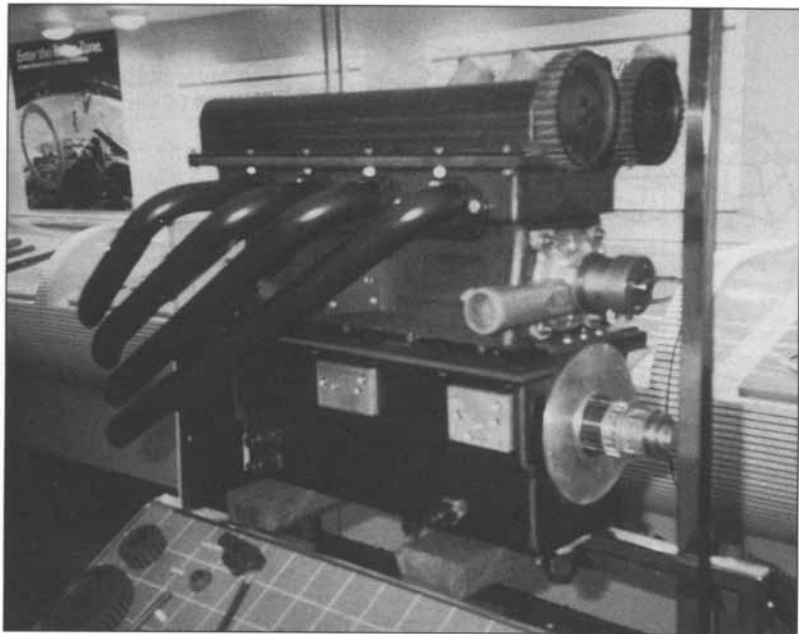

*Photo 43-2 A polimotor plastic engine: 2L displacement, 318 PS/9500 rpm.*

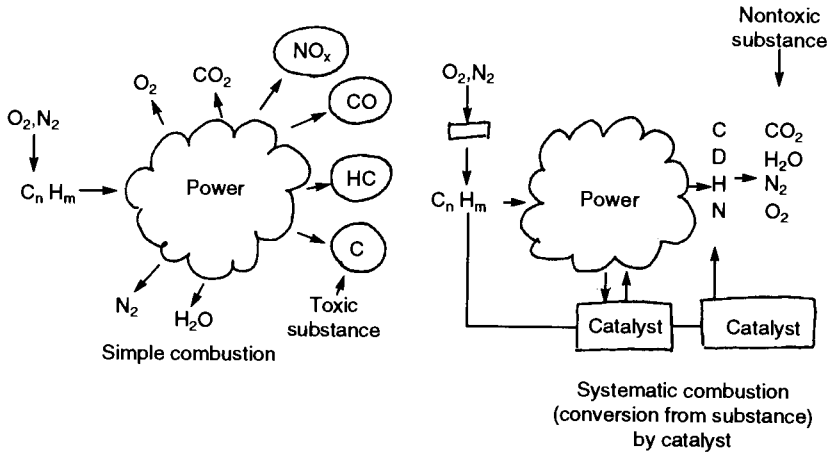

*Fig. 43-11 Simple combustion and systematic conversion from substance.*

## **Scientific Technology That is Harmonious with Nature**

Needless to say, scientific advances have not been restricted to engines. The engine has enabled us to enjoy an almost unlimited convenience and satisfaction. At the same time, the disadvantages of the engine, such as exhaust emission and vehicle safety problems, have become extremely pronounced. Originally, the engine was conceived by Huygens in the 17th Century to

reduce labor's burden on humanity, that is, the engine originated from humanism (refer to Chapter 1). However, the engine can also result in degrading humanism. The engine and its related scientific technologies have advanced to their present levels based on European rationalism. The earth's environmental conditions have considerably deteriorated. I think it is now time to re-evaluate the engine, returning to its point of origin.

The bases of European rationalism and scientific technologies have consisted of opposing and, therefore, conquering nature. The gardens of Versailles required an enormous amount of water, necessitating some motive power. On the other hand, Korakuen, a representative Japanese garden, is shown in Photo 43-3. The beautiful pond water in the garden was channeled from the Asahi River, flowing through Okayama. No motive power was

required. The garden is merged into nature by modifying, rather than opposing nature. The early Japanese culture accepted our environment as it was and did not oppose it. In fact, harmony with nature was the very basis of Japanese culture. I feel that future scientific technologies should incorporate the mind of the original Japanese culture, that is, harmony with nature and an embedded presence in nature.<sup>(43-5)</sup>

However, the logical and mathematical thinking that originated from Descartes is the origin of all scientific technologies. Original thought that supports the advance of scientific technologies cannot grow without this mode of thinking. Therefore, I propose that future scientific efforts merge Japanese thinking with the Descartes system, that is, future technology should be based on the consolidation of these two modes of thinking. Note that the idea of the engine was conceived by Christiaan Huygens as mentioned earlier. His father, Constantine Huygens, was taught personally by Descartes, who had moved to the Netherlands. It may be said that the engine is the technological fruit of the materializations of Descartes' thinking. As mentioned previously, technology has continued along the pathway blazed by his thinking. On this same pathway, the Japanese way of thinking should now be imposed (Fig. 43-13).

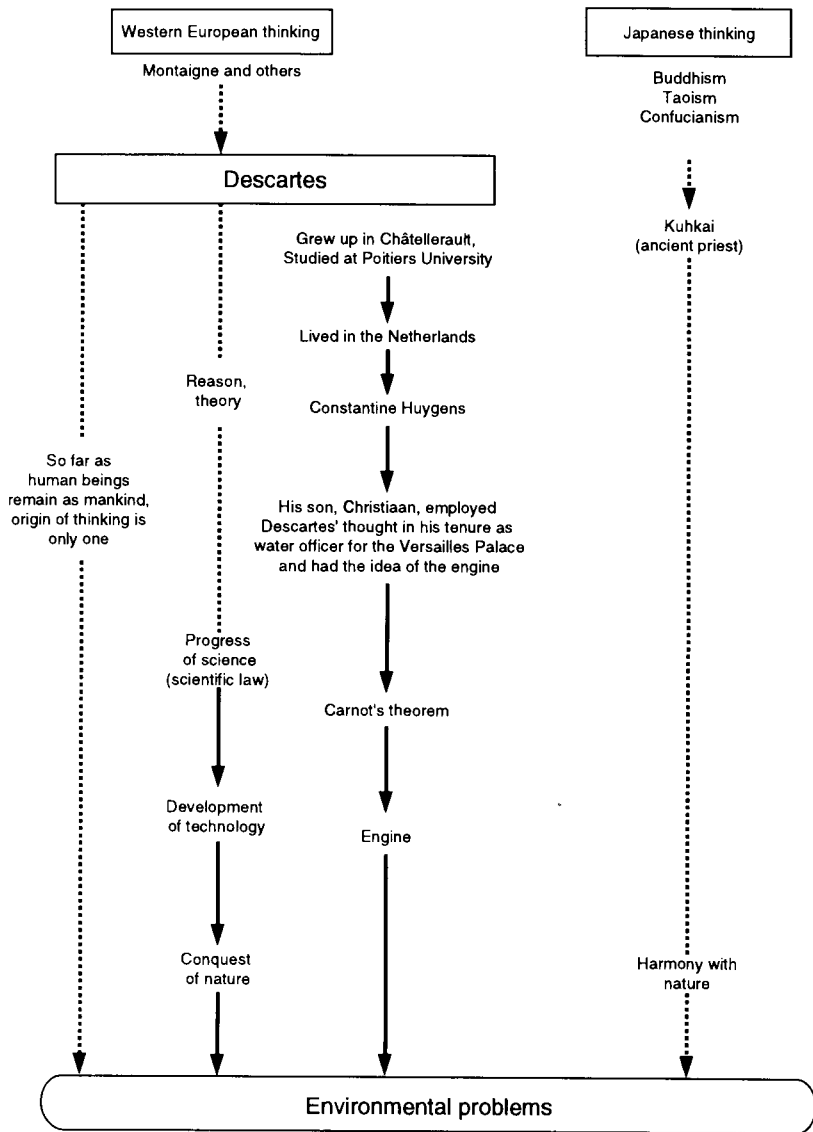

*Fig. 43-13 Scientific technologies must be advanced while keeping a balance between Descartes' rational thinking and the Japanese objective of being in harmony with nature.*

In 1967, Arthur Koestler proposed the concept of *holonics*. This concept means that current individual technologies are to be moved in the direction that would ensure harmony with the entire environment. This concept is



none other than the superimposition of the Japanese mind on that of Descartes. Our technologies must merge with the concept of holonics.

Presently, the benefits of scientific technologies are concentrated in the northern hemisphere. Many people in other areas of the world also want the benefits produced by this technology. The next-generation scientific technology must correct this imbalance as well as ensure harmony with the earth and with nature. This unmarked trail must first be blazed by the engine, which has been making the greatest contribution to the convenience of mankind today. Both the dream and the work of engineers are unlimited.