

<b>Book:</b>	Waterways & Wetlands
<b>Chapter:</b>	13 Dams, weirs and sluices
<b>Section:</b>	Dams
<b>Meta Data:</b>	<a href="#">Details</a>



Dams are barriers which block water but which are not designed to be overtopped by it except where an overflow is provided.

## Why dams fail

Dams most often fail for one of the following reasons:

1. Not enough allowance is made for the settling of soil in an earth dam. The result is that the dam is overtopped.
2. The overflow capacity of an on-stream dam is too small so that the dam is overtopped in a storm. Overflow design is discussed further below.
3. The top is not wide enough or there is erosion from wave action, or both. The result is a breach in the dam.
4. Unsuitable materials have been used which, combined with internal seepage, causes the dam to give way from within. A similar effect can be caused by the sudden drawdown of the reservoir's water level, leaving the water level within the dam higher than that on either face.
5. Internal erosion ('piping'), often due to seepage along a pipe, causes the dam to collapse from within.
6. Retrogressive erosion occurs at the spillway or outflow below the dam caused by steep slopes or inadequate channel protection. This may occur naturally where a dam is built above a point of active stream rejuvenation but more often it results from faulty construction of the overflows themselves. The result is that the dam is undermined from the front or that it is outflanked and water pours out of its eroded edge.
7. The barrier is not properly keyed into the banks and side so that it either fails due to seepage or continues to stand but functions poorly.
8. The materials of a wooden, brick or concrete barrier have deteriorated due to age.

## Earth dams

This section applies in general to all impermeable earth embankments, although not all require outlets and overflows. Very small spoil dams, which are less difficult to construct, are discussed at the end of the section.

### Site selection

General factors influencing site selection have been discussed in the chapter on 'New Ponds'. To further investigate the location, dig a number of trial holes, sinking them well below the depth of any proposed excavation or in any case at least 1m (3') deep. Dig a hole in each corner of the site. It is best in the case of a long dam to dig holes every few yards along the centre line in order to locate any old hidden stream beds which often run across valley floors. Note the following:

1. If the subsoil is permeable, a core trench must be dug and filled with clay to key into the core of the dam. If the substrata is rock, the construction will be costly because a cut-off trench must be dug or blasted along the line of the dam in order to block seepage which otherwise would occur through fissures in the rock.
2. Most soils are sufficiently stable to bear the weight of an earth dam but peat, topsoil or soil containing organic matter is unsuitable and must be stripped from the site. It is also best to level the site, even though dams are only likely to slip due to horizontal thrust of water on very steep sites.

### Test and preparation of dam materials

The tests below give an indication of soil quality. When in doubt send a sample to a soils laboratory for testing.

The 'worm test' gives a general indication of clay in the soil. Take a small handful of soil, pick out any large pebbles and roll the soil between open palms as if making a clay worm. Suitable soils for homogeneous earth dams become moist on the surface and rather plastic when manipulated, while soils with too little clay fall to bits. In addition, suitable soils become slightly sticky when wet, stain the hands and have a gritty feel when rubbed between the fingers. If the soil lacks 'fines', especially clay, an impermeable core must be provided. Suitable clay for the core, as well as for puddled pond linings, is plastic when moist, tenacious to handle and contains at least 30% clay fractions.

The 'rapid sedimentation test' gives a more accurate estimate of the percentages of clay, silt, sand and coarser particles in the soil. Take a handful of soil, pick out and discard the larger stones and put the remaining soil in a jar or, preferably, a graduated cylinder. Top up the container with water, shake it to mix the material and set it aside to settle undisturbed for 24 hours. If possible, add a few drops of sodium silicate (waterglass) to speed the process. The coarsest particles immediately settle while a small proportion of the clay may persist in suspension after the period is up. Silt and clay may appear very similar in particle size but they are noticeably different in colour and the clay comes to rest on top.

The best soils for homogeneous earth dams are loams, clay loams, sandy clay loams, or 'hoggin' (mixed sand, gravel and clay) having not less than 20% nor more than 30% clay, with the rest being well graded sand and gravel having, ideally, 30% of the total as fine sand and 50% as coarse sand and fine gravel. Adequate though less good soils contain 10-25% clay and not more than 30% silt for a total of not more than 50% clay plus silt.

Soil with a very high clay content expands when wet and shrinks and cracks on drying. Such soils should only be used in zoned or diaphragm construction, if surface cracking and erosion is to be prevented without excessive maintenance.

Peat is too weak to use in dams, especially if subject to wave action or disruption by tree roots. It can, however, make a relatively watertight bank provided it is well consolidated and packed. It works best where the bank represents the last of the original peat still in place while the peat has been dug out and removed to either side. Seepage through wet peat is very slow, so it acts as a buffer between water lying to both sides. If the water level drops on one side it takes some time before the other side begins to filter through to compensate.

### General design requirements

The general design requirements of a typical onstream dam are discussed in Chapter 6 and shown in the diagram on page 51. The dimensions and slopes indicated in the diagrams which follow are minimal. The wet slope, for example, should be no steeper than 1:2.5 and preferably 1:3. The normal freeboard should be at least 1m (3') below the dam crest although very small dams where waves are unlikely to be more than a few inches high could allow less. Where a dam is built next to an excavation there should be a 3m (10') 'berm' (shelf or shoulder) between the excavation and the dam for adequate stability.

### Homogeneous dams

The diagram below shows a homogeneous dam on impermeable soil.

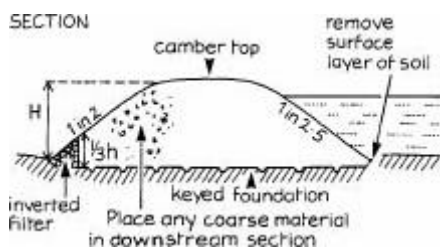

The diagram below shows a homogeneous dam on permeable soil, with a cut-off.

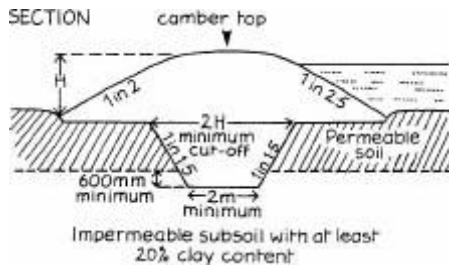

Homogeneous dams are constructed of impermeable soil throughout. This is the cheapest method if the soil is suitable, i.e. well graded with 20%-30% clay and with the non-clay fraction containing a fairly high proportion of coarser particles to increase stability and aid compaction. The clay content must not be too high or the soil will shrink on drying and be unstable.

Seepage will occur but should remain at an acceptable level given suitable soils. If seepage water passes through the dam to emerge on the dry slope it may erode this slope and eventually weaken it. The solution is to draw down seepage paths so that the water emerges at the toe of the embankment. This can be done, if necessary, by replacing the soil at the toe with an inverted filter of evenly graded materials as shown above. Erosion may occur on the wet slope if the pond water level is drawn down more than 150mm (6") a day.

### Zoned and diaphragm dams

These types are made of permeable soil with an impermeable core. The permeable soil must be stable but it is the core which forms the actual seepage barrier. If supplies of impermeable soil are adequate it is best and cheapest to build the zoned design, with the permitted core widths shown below. The more permeable the soil used in the core the wider the core must be to provide an adequate seepage barrier.

The diagram below shows a zoned dam on impermeable soil.

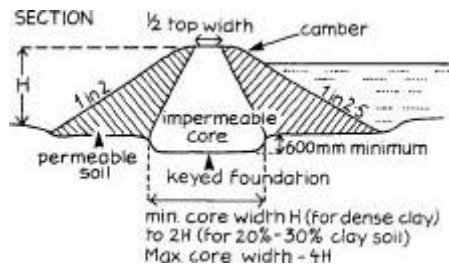

The diagram below shows a zoned dam on permeable soil.

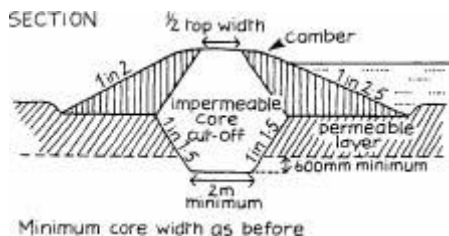

The diaphragm construction should be made with a puddled clay core.

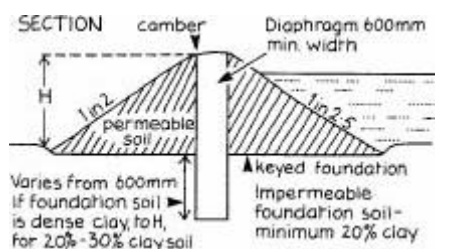

## Blanket dams

Where suitable impermeable soils are available only in very limited quantities the dam may be built of permeable soil with a waterproof blanket on the wet slope. Suitable blanket materials are dense clay, PVC or butyl rubber (see [artificial linings](#)).

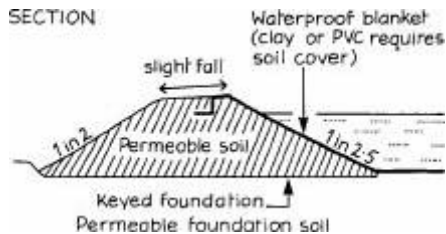

## Construction

Earth dam construction work must be carried out in stable conditions. The best time is summer, especially May and June when rain is least likely.

1. Strip the topsoil over the area of the dam. Set it aside for reuse. Grub up trees and shrubs as necessary.
2. Scarify the sub-soil along the line of the dam using a plough, disc harrow or hand tools. This improves the seal between the dam and the foundation by creating parallel corrugations at right angles to the line of possible seepage flow.
3. Key the dam into impermeable subsoil, or if this is too deep, dig a cut-off trench as illustrated above.
4. If the dam is to have a bottom outlet pipe (see below), this should be laid in a narrow trench excavated in the foundation soil to a depth equal to two pipe diameters. The concrete anti-seepage collars should pass through the trench walls into undisturbed soil. After laying the pipe, refill the trench with soil of a high clay content and thoroughly compact the soil around the pipe and collars.
5. When building an on-stream dam the stream must be carried through the work area by way of a bottom outlet pipe or a by-pass channel. These may be temporary or designed as permanent features. It may be necessary to divert the stream by means of a temporary dam located upstream and clear of the toe of the permanent dam. If there is no low-level outlet and the dam is long, the temporary by-pass channel should be shifted progressively towards the eventual primary overflow, in order to keep the stream flowing well around to the side of the enlarging dam. The old stream bed should be filled in across the line of the dam.
6. Build the dam in layers extending over the full width and length of the embankment. The layers should be spread about 150mm (6") thick and then compacted. Compaction can be by hand, or rather by heel, but this is extremely laborious. Impermeable soil to be 'heeled in' should be in a plastic condition.
7. It is most efficient to compact the soil mechanically. For fairly small dams this can be done with a roller, or with a power tamper, available from hire firms. Large dams can be compacted by means of heavily loaded rubber-wheeled vehicles which impose concentrated loads on the soil. Tracked earth-moving vehicles are less good because they exert less pressure. Impermeable soils should not be plastic if they are to be compacted mechanically. Squeeze a small ball of soil in the hand; it should not be so soft that it deforms to the shape of the hand nor so dry that a small dent cannot be made by pressing hard with the thumb. Do this test with a freshly dug sample because soil dries rapidly when handled.
8. If the dam is composed of an impermeable core with permeable outer layers, build up the core at the same rate as the rest of the dam. The core should be of the consistency already indicated for hand or mechanical compaction. The permeable outer soil should not be so plastic that a deep depression is formed by the heel, but it should be possible to just dent it with the heel.
9. When work is left overnight or at weekends, the top of the structure should be given a slightly cambered profile. This allows rain to run off and minimises any damage should the stream break its temporary bypass channel. If the work is left for several days in very dry weather, the surface should be watered, harrowed and recompacted before adding more fill.
10. The dam settles after completion so it must be built higher than its specified final height. Allow 10% extra height for settling after mechanical compaction or 20% for settling after hand compaction. Finish the dam with a slightly cambered profile to aid rain runoff.
11. Replace topsoil on parts of the dam not below the anticipated water level.

## Protecting the finished embankment

1. Spread grass seed immediately upon finishing the dam. This helps stabilise the soil and minimise erosion as well as prevent the growth of coarse weeds, scrub and trees. Remember, though, that the use of ordinary grass seed mixtures may introduce new species into areas of natural interest where they would not otherwise occur. Where this is not a problem, the best grasses are strains of creeping bent (*Agrostis stolonifera*) and rough-stalk meadow grass (*Poa trivialis*) which flourish in wet or dry conditions and are fairly low growing. Their seed costs more than ordinary grass seed and the banks must be covered with fine soil before sowing.
2. Small herbaceous plants, rushes and aquatic grasses make effective shoreline stabilisers and may be planted to give a 'natural' look to a small dam, but some species spread and may need later control. Do not plant anything deep-rooted.
3. If the soil is highly saline, as is often the case in coastal barriers, vegetation may be very slow to take hold. Wire netting or a suitable geotextile can be staked across the face of the bank to help to keep it from slipping until vegetation is established.
4. The area around the water line may need special protection against wave erosion. Use stone pitching or floating or fixed wave barriers.
5. The intersection of an impounding dam with its valley sides forms natural drainage channels. This area may need special attention to prevent erosion.
6. Fence the dam as necessary to keep off people and large animals.

## Maintenance

Inspect the dam periodically

1. Check the overall stability and general condition. Watch for gullyng, slips and undue settlement which may indicate internal weakening.
2. Fill cracks which appear during dry weather.
3. Check for seepage. If this is slight and confined to the area downstream of the toe it is not serious. But if seepage increases rapidly you must correct it immediately, before the dam erodes from the inside. To correct dangerous seepage, excavate the toe and replace it with an inverted filter of evenly graded materials, as shown in the diagram of the homogeneous dam below.
4. Weed any trees and shrubs on the embankment and spillway.
5. Check the conditions of the overflow spillway and outlet pipes, and restore eroded areas, damaged concrete and silted catchbasins.

## Small spoil dams

Dams can easily be made by simply heaping up and compacting the spoil from a pool excavated upstream. They should be kept under about 300mm (1') in height unless they are built to the same standard as full-scale earth dams.

The main problem is seepage, especially when the dam is made of turf or peat. Polythene sheet held against the upstream side with turf or additional soil may be used to form an impermeable barrier. Old doors, discarded sheet metal and so on can also be used and work well as long as the structure is so small that no joining is needed between these items. Whatever the impermeable material, its bottom edge should be placed in a trench and anchored with puddled clay or compacted soil to minimise seepage underneath.

## Overflow and outlet design

### Basic overflow requirements

Off-stream dams do not require overflows provided they receive little runoff from surrounding higher land and provided that the inflow can be controlled. On-stream dams must have adequate overflows to prevent overtopping and failure during floods. There are two basic design requirements:

1. The overflow must be adequate for a defined level of catchment runoff, including an allowance for very occasional catastrophic storms, without the dam being overtopped.
2. The overflow must withstand erosion under all conditions. The calculations of catchment runoff and overflow capacity are complicated, and expert advice should be sought on the construction of any new on-stream dam.

### Single versus dual overflow

Various designs and dimensions of overflow may accommodate the calculated catchment and storm runoff. The simplest approach is to build the dam with a single overflow designed to take all runoff levels. This is best where the catchment is mainly permeable and the terrain flat and well vegetated. Here there is only a slight variation in flow between normal and storm conditions so there is no need to build the overflow wastefully large to take occasional extraordinary levels. Because it is in continuous use, the single overflow must be paved, concreted or otherwise protected. It may be a short steep chute ending in a stilling basin, a long low weir or a sluice with gates, depending on the situation.

Where a single overflow must be made impracticably large to handle storm runoff or there is a great difference between normal and storm flows, a dual system is cheaper and simpler. A dual overflow incorporates a primary overflow to take normal runoff and a storm overflow (spillway) which comes into occasional use after storms. The primary overflow may be identical to but smaller than the overflow of a single overflow dam, or it may be a brick or concrete weir chamber, in which case water is taken out from under the dam via a pipe.

### Primary overflow weir chamber

This design has a capacity of 3 cusecs per foot length of weir at 300mm (1') head. It can be made of brick or concrete, and should be located at the edge of the pond near the opposite end of the dam from the spillway. A pipe with watertight joints carries the flow from the weir under the dam to the downstream watercourse. The pipe should be laid at an even slope in the existing ground and should end at a bottom outlet bay such as that shown below.

The primary overflow should be able to discharge 1/10 cusec per acre of catchment, provided that sufficient freeboard is left between the level of the primary overflow and that of the spillway crest, i.e. 300mm (1'). The spillway can then be designed as a gently sloping grass bank taken around one end of the dam. The spillway's capacity depends on the 'control section', a level straight portion of channel extending about 7.6m (25') downstream from the spillway crest. There should be 600m (2') freeboard between the spillway crest and the top of the dam.

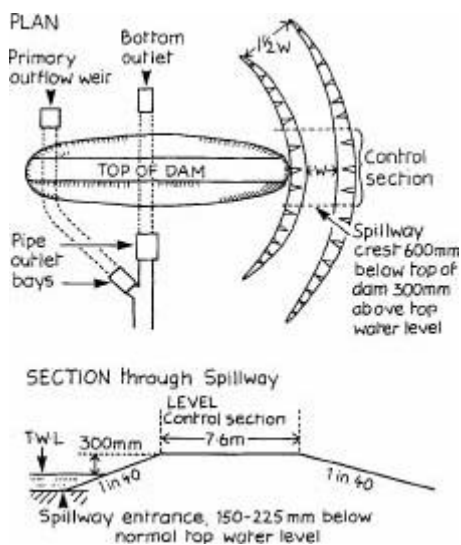

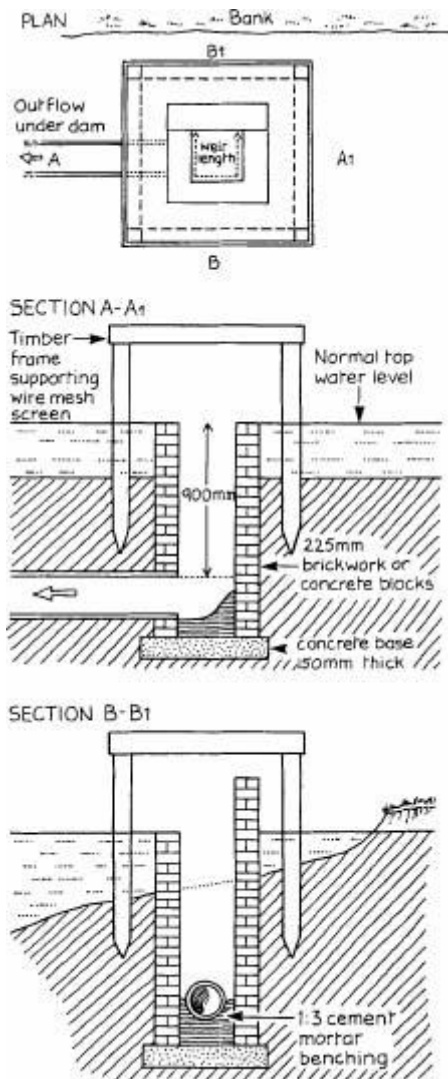

The spillway shown on the previous page is designed to come into use fairly frequently, several times a year in most catchments. To protect it from erosion it should be seeded or turfed as soon as possible after construction. Turfing is the safest, quickest method of ensuring a grass cover but the turfs should be staked or wired if the spillway is likely to come into use before they have properly knitted to the underlying soil. Where velocities cannot be kept below 1.6m (6') per second, the grassed surface may erode, threatening the dam structure. In this case the spillway should be covered in PVC or butyl rubber sheet, unless there is seepage through the spillway, in which case the sheeting is likely to lift and stone pitching or gabion 'mattresses' should be used instead (see [banks, revetments and access](#)).

For small dams it is possible to have a simpler dual overflow system with a primary overflow and a spillway designed to come into use once every two or three years at most. This spillway can, in effect, be part of the dam or earth bank provided its slope is no steeper than 1:3, the surface has a good grass cover and the head over the spillway is never more than 75-100mm (3-4"). The primary overflow should be set 300mm (1') lower than the spillway, as in the more complex system already described.

### Bottom outlet

A low-level outlet at the base of the dam has several advantages :

- During and after construction it can channel compensation water to riparian owners downstream.
- It allows the pond to be emptied when necessary for repair or cleaning.
- If the inflow into the pond is adequate the outlet can be left partly open to allow a flow-through of water in order to keep deep areas well oxygenated. This requires that the pond levels be checked frequently, however.

It is possible to combine a bottom outlet with a primary overflow, through what is known as a 'drop inlet', but this requires a large-diameter pipe to cope with the flow. A separate bottom outlet can use a smaller pipe but it should not be less than 150mm (6") diameter for the size of the dam under discussion here. The pipe must be watertight and carefully laid in a trench excavated in solid ground below the dam. Anti-seepage collars are necessary to prevent seepage along the outside of the pipe which could weaken the dam.

SECTION through Bottom Outlet

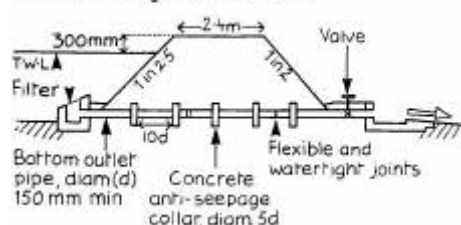

The entrance to the bottom outlet should be located well clear of the dam and should be 150mm (6") or so above the bottom to compensate for silting. It is best not to locate the opening in a small deep pocket. The end of the pipe should be protected with a trash screen to keep debris from entering the pipe. The floor of the inlet chamber should be at least 150mm (6") below the invert of the pipe.

The downstream end of the outlet pipe should be carried well beyond the toe of the dam and should feed into a watercourse via an outlet bay. The watercourse may need revetments or other protection against turbulence.

PLAN 'd' = inlet pipe diameter

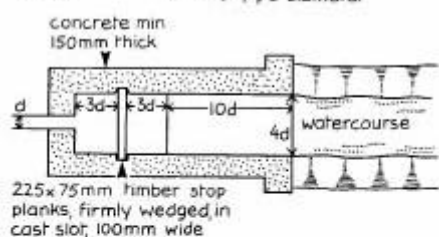

SECTION

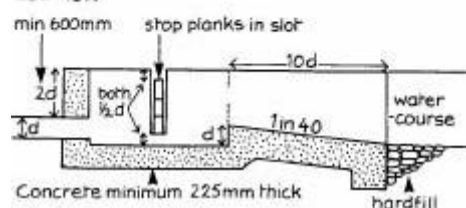

All bottom outlets should have a valve or plug to allow the outflow to be stopped or controlled. This should be at the upstream end, if possible, to reduce pressure within the pipe but in the case of a separate outlet the valve is more cheaply and simply installed at the downstream end where it is easily accessible. In this case especially it is important that the pipework and joints be good quality. A drop inlet can have the valve at the bottom of the drop shaft at the upstream end of the pipe, controlled by means of a long rod and wheel from above.

## Wooden dams

### Sleeper dam

Sleeper dams are extremely easy to construct but are prone to leaking. They must be well bedded into the banks on either side or set against posts if they are not to be carried away by storms. The design above is adequate for shallow streams and can back up water 1-1.2m (3-4') deep. It can function as a weir with a breakwater placed below the downstream face.



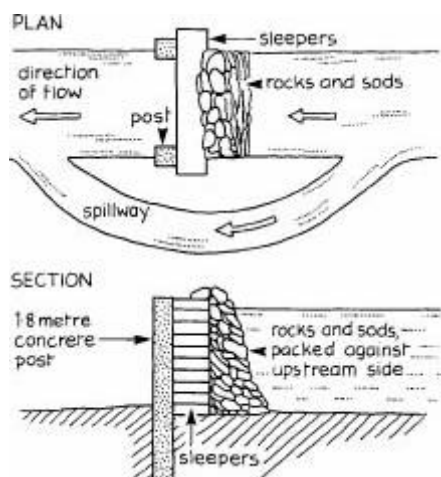

### Standard board dam

This is made of boards pre-cut to a standard specification so that they fit together tightly and can be replaced or reused without difficulty.

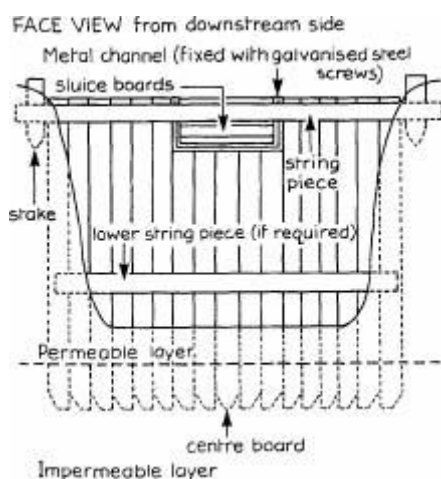

This design also makes a good weir on a narrow watercourse, as long as a breakwater is placed below the downstream face. More often it is provided with a sluice opening to control water levels, as shown in the diagram, in which case no other overflow is required.

The boards must be machine-cut by a timber merchant for accuracy. Elm or oak boards are best and need not be treated with preservative. Much cheaper are pressure-treated larch or Scots pine timbers.

1. Determine the required board length. To do this, take soundings in the channel bottom where the dam is to be placed. Use a long 6mm diameter steel rod and push it in as far as you can, or use a borer to take out a core sample. When using a rod be sure to push it through any thin seams of impermeable material down to the true solid bottom into which the boards must be driven. If the boards are driven only into permeable soil or peat the water will force its way underneath the dam to burst out perhaps as much as 6m (20') downstream. The boards must be long enough to raise the water to the desired level.
2. Lay a solid timber across the channel from which to work.
3. 'Strike' the dam's centre board. This is the only board which is chamfered on both edges. Drive it in with a maul, making sure that it stands absolutely vertical.
4. Drive in a board next to the centre board, with its chamfer away from the centre board. The effect of the chamfer is to push the board tight against the centre board as it is driven in.
5. Next drive a board on the other side of the centre board, the chamfer facing away.
6. Continue to strike alternate boards, building the dam towards each shore. Make sure the boards are driven into the impermeable substrata as measured by your soundings.

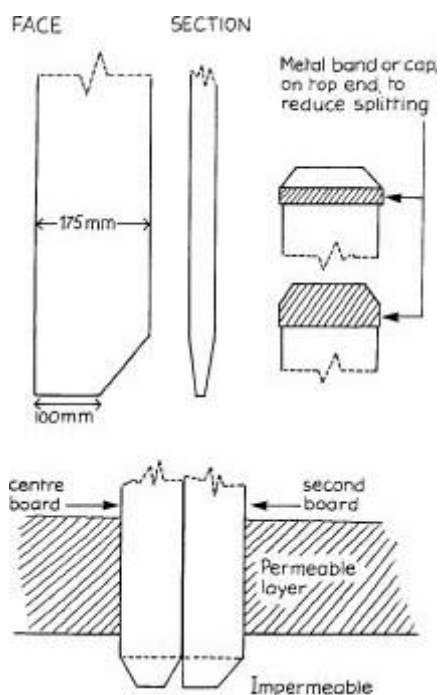

8. The dam must be properly keyed into the bank. This means driving the last board on each side down through the bank so that at least half its width is in the bank. Where the bank is too hard for this, make a water-tight corner instead, by driving in a couple of boards at right angles to the line of the dam where it meets each bank. Set the chamfer away from the dam so that the corner boards are driven tight against the last board in the dam itself.

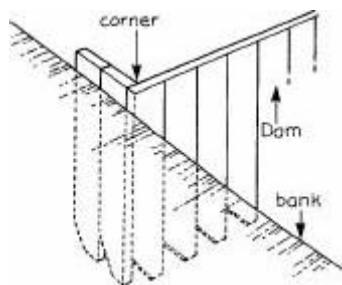

- 9. These corners also discourage voles and rats from burrowing around the ends of the dam and perforating the bank, although there is no guarantee that seepage from this cause will not occur.
- 10. After the dam is in place, cut out the opening for the sluice gate and screw in the metal channel. Slide in the sluice boards.

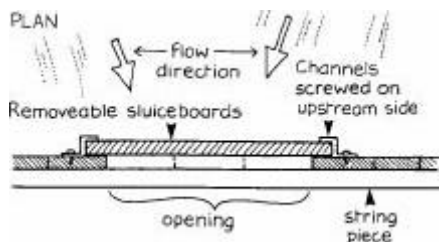

- 11. Wide dams require a 'string piece' across the top to hold the dam boards in place and keep them from spreading. For example, on a 4-5m (15') wide dyke a 180 x 100mm x 6m (7" x 7" x 20') string piece should be used, set into the sides of the dyke against the downstream side of the dam and held by stakes if necessary.
- 12. Channels 2.4m (8') deep or more require another string piece set at the bottom to counteract the water pressure which might otherwise burst the boards at the base. To install the bottom string piece, place a coffer dam, construct shuttering if the banks are soft peat, silt or sand and pump the work area dry. Dig out

13. holes into which the string piece fits, slide the string piece into place and compact the soil around it so that it sits solidly.
14. Where a string piece is not required it may still be convenient to lay a plank across the channel as a bridge and to reach the sluice boards. Firmly secure the bridge by driving stakes on either side or by digging it into the earth.
15. If the dam boards spread slightly at the top, small gaps or 'finger holes' can be plugged by sprinkling a few spadefuls of dry peat or other dry black earth on the boards on the upstream side. With luck the earth will be drawn between the boards and seal the cracks.

## Filled sack dams

Sand, clay or concrete-filled sacks can be piled into dams exactly as for wave barriers (see banks, revetments and access). Use woven polypropylene bags and pack them around with clay if it is important to cut down seepage. These structures can also function as weirs as long as a breakwater is installed below the downstream face.

Sandbags can be combined with wooden or iron pickets and galvanised iron sheeting to make a dam capable of backing up a maximum of 1.5m (5') of water in a stream 300-600mm (2-3') deep. The dam must be provided with a spillway around one end, with its crest 300mm (1') below the top of the dam, to prevent the dam being overtopped and eroded.

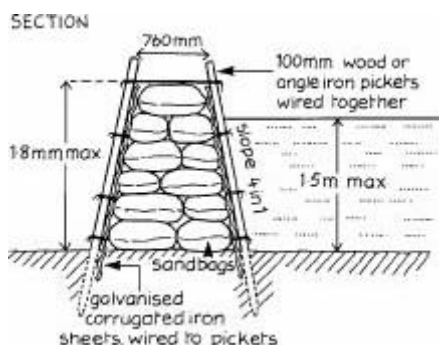

## Coffer dams

Coffer dams are temporary structures positioned to hold back water and create a dry place in which to work. They are often used to isolate areas of waterways which are to be cleaned or to allow permanent dams or bankworks to be repaired or rebuilt. Although they do not need spillways, in all other respects they must be given the same sort of forethought and care as permanent dams.

It is not possible to specify designs for coffer dams since the choice of materials and the size and strength of dam required varies with each situation. A few general points should be kept in mind :

- Earth or clay dams are very likely to fail for reasons given earlier in this chapter. The care needed to make them really safe usually requires more work than is justifiable for a coffer dam.
- Sandbag barriers make good low-level dams. A single row of bags, stacked across the channel in staggered layers, is sufficient where no more than 600mm (2') of head is created. A double row allows up to about 900mm (3') of water to be backed up. This type of dam is not watertight and the work area must be continually pumped.
- Where the head of water is greater than 600-900mm (2-3') and the area to be dammed is not too wide it is best to construct a wooden dam following the procedure described above. This is most easily done if the proper boards are used. The materials can be recovered afterwards.
- A simple timber coffer dam can be made with a double row of boards packed between with earth or clay.

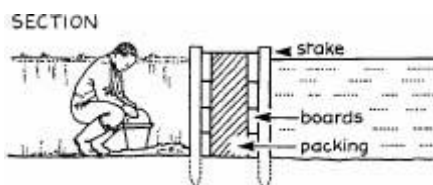

- If the head of water is considerable, ie 1.2m (4') or more, it is easier to build a double dam than to make a single coffer dam of adequate strength. Allow about 3m (10') between the two dams. It is important that the water level between them be half way between that of the outside water level and that of the work area, so that the pressure is shared equally. In still water this may be achieved by pumping out between the dams to the correct level, while in flowing water the dams must incorporate overflows or diversions at the required heights.

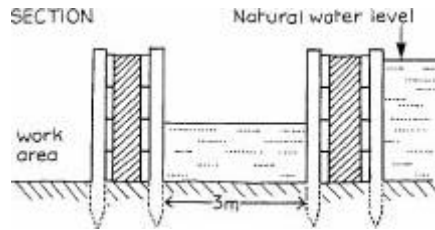

- Be sure that the banks are stable before pumping out the water. Quite often it is necessary to reinforce them with revetments or timbering to keep them from slumping. Large dykes, especially in peat, must be strengthened by a complete box of strong shuttering around the work area.

All content copyright © 2001 BTCV Ltd. Registered charity No. 261009