

A. SMELOV, I. UDALOV,
V. CHERKUN, A. ASTRAKHANTSEV

MAINTENANCE
OF AUTOMOTIVE
ELECTRICAL
EQUIPMENT

Translated from the Russian
by
George ROBERTS

MIR PUBLISHERS • MOSCOW •
1971

REPAIR OF STORAGE BATTERIES

The most likely troubles of storage batteries are: high standing losses, abnormal sulphation, buckling, internal short circuits, deterioration of cell plates, breaking of plate lugs away from plate connecting straps, deterioration of separators, and damage of battery containers.

High standing losses may result from: short circuiting of terminal posts by spilt electrolyte and dirt on the cover

of the battery container, internal short circuiting of cell plates by active material dislodged in service, shorting of plates caused by breakdown of separators, impurity of materials employed, stratification of electrolyte.

The standing losses are mainly due to the effect of local currents produced by local galvanic couples that are formed by metallic plate grid impurities in the presence of electrolyte. Metallic impurities introduced accidentally into the electrolyte are dissolved by the sulphuric acid and deposited on the negative plates during the process of battery charging. As a result, these metallic impurities also form galvanic couples with the lead of the plate grids.

The local currents produced in this manner discharge the negative plates of the battery and convert the sponge lead into lead sulphate. Local discharge of the positive plates during periods of inactivity is mainly due to the presence of organic impurities in the electrolyte and plate material. The active material of the positive plates and antimony are also liable to form galvanic couples with the grid lead and cause local action.

The standing losses resulting from local action increase with the amount of impurities contained in the battery. Therefore it is strictly forbidden to use impure lead, sulphuric acid, water, and other materials containing foreign matter liable to increase the standing losses and deteriorate the cell plates.

Never use commercial sulphuric acid and river, well, or spring water for preparing the electrolyte. In exceptional cases, however, rain water or thawed snow may be used for this purpose, provided they have not been collected from iron-covered roofs or kept in metal vessels.

Abnormally rapid discharge followed by establishment of a normal cell load voltage on recharging the battery may result from contamination of the electrolyte which should, in such cases, be immediately renewed. To do this, first discharge the battery to a final voltage of about 1.2 V per cell in order to transfer the metallic impurities from the negative plates to the electrolyte. Then drain the electrolyte from the battery container, wash the battery thoroughly with distilled water, fill the container with fresh electrolyte, and charge the battery.

During long periods of inactivity, the specific gravity of the electrolyte at the bottom of the battery container

may become greater than at the top. Such stratification of the electrolyte produces local equalizing currents which increase the standing loss of the battery.

Sulphation of the cell plates lowers the battery capacity and increases the internal resistance of the cells. Large crystals of white-coloured sulphate form on the surface and within the pores of the active material of the positive and negative plates; the active material hardens and becomes covered with white spots. Intensive sulphation results from keeping partially discharged batteries inactive for long periods of time, from frequent overdischarges, and from exposure of the upper parts of cell plates to the effect of the surrounding atmosphere on lowering of the electrolyte level. Sulphation increases the specific gravity and temperature of the electrolyte, as well as the standing losses of the battery. Sulphated batteries are of low ampere-hour capacity, discharge rapidly, and become unfit for further service.

The formation of crystalline sulphate leads to an increase in volume of the cell plates and may eventually set up internal mechanical stresses liable to damage the cell plates and separators. To prevent rapid sulphation, maintain a normal level of electrolyte in the battery cells, take discharged batteries out of service in due time, avoid high specific gravities of the electrolyte, use pure sulphuric acid and distilled water for the electrolyte, and keep the charged batteries at ambient temperatures not higher than 0°C .

The remedy for moderate sulphation of the cell plates is to charge the battery for a long period of time with a low charging current. The battery should be filled with clean distilled water and charged at a rate not over $\frac{1}{20}$ normal capacity. On attaining a specific gravity of 1.15 replace the electrolyte by clean water. Continue to charge the battery in the same way until the specific gravity of the electrolyte remains constant.

Buckling of the cell plates occurs when their temperature rises above plus 45°C , on passage of a heavy charging or discharging current, in the event of a short circuit, reversal of the plate polarity, sulphation, lowering of the level of electrolyte, and exposure of the upper part of the cell plates.

In all of the above cases, buckling (primarily of the

positive plates) results from unequal growth of the active material on opposite sides of the cell plates.

Buckling produces cracks in the active material which eventually falls away from the plate grids, resulting in loss of ampere-hour capacity. Short circuits of the cell plates are caused by puncture of the separators and when a considerable amount of active material drops to the bottom of the cell containers. A shorted battery discharges rapidly and its plates become sulphated. Such internal short circuits should be eliminated during repairs of the battery.

The cell plates deteriorate when the charging period is too long or the charging rate too high and, also, at an excessive temperature or specific gravity of the electrolyte. All this is accompanied by intensive gassing, collection of gases in the pores of the active material, and an increase in internal pressure which causes loosening, crumbling, and shedding of the active material. The active material of the positive plate is more susceptible to mechanical damage than that of the negative plate and, consequently, disintegrates more rapidly.

Freezing of electrolyte and corrosion of positive plate grids on introduction of other acids into the electrolyte also cause the plates to deteriorate and break away from their connecting straps.

Cracks in the cell containers are due to mechanical damage, but may also result from intensive sulphation and buckling of the cell plates. Leakage of electrolyte from such cracks leads to exposure of the cell plates and their sulphation. Cracks in the intercell walls of the containers cause rapid self-discharge of the battery, since the plate banks of different polarity become short circuited.

Storage battery repairs consist in checking, disassembling, reconditioning, assembling, charging, and testing the battery in question.

Repair of plate banks is the most difficult task of all and may involve manufacture and installation of new or reconditioning of old plates.

In recent years it has become common practice to recondition old plates in specialized repair workshops, this being accomplished by carrying out the following main operations: checking the general condition of the storage battery; charging; disassembly and inspection; washing

all parts and units; disassembling battery units and inspecting their components; reconditioning old and manufacturing new parts; reassembling the units; reassembling the storage battery; filling the battery with fresh electrolyte and charging; testing the battery.

Clean the storage battery thoroughly of accumulated dust and dirt with a clean cloth soaked in a 10-per cent aqueous solution of ammonium hydroxide.

Inspect the battery for the following defects: damaged terminal posts; oxidation; contamination; stripped screw threads and cracks in the vent plugs; cracked covers; damaged sealing compound; cracked and chipped containers; leakage of electrolyte.

In cases when the battery is without polarity markings, the terminal posts can be identified by either of the two following methods:

immersing the ends of wires connected to the terminal posts into a vessel filled with electrolyte. Bubbles of hydrogen gas evolve more intensively from the end of the wire connected to the negative terminal post;

connecting the leads of a d.c. voltmeter to the terminal posts of the battery. Deflection of the pointer indicates that the voltmeter has been connected correctly and at the same time allows the polarity of the battery terminal posts to be established.

Check the level of electrolyte in the storage battery by fully inserting a glass tube in the filling hole of each cell, stopping the upper end of the tube with a finger, withdrawing the tube and noting the level of electrolyte. This is illustrated in Fig. 144.

Always measure the level, specific gravity, and temperature of the electrolyte in the same sequence—proceeding, for example, from the positively to the negatively marked cell.

Measure the specific gravity of the electrolyte in all the battery cells by squeezing the rubber bulb of a syringe hydrometer, immersing its tip in the electrolyte, and releasing the bulb so as to suck electrolyte into the glass barrel until the hydrometer floats.

On this being achieved, lift the hydrometer and read the specific gravity (Fig. 145). The temperature of the electrolyte has considerable effect on the readings. Therefore, measure the temperature in all of the battery cells

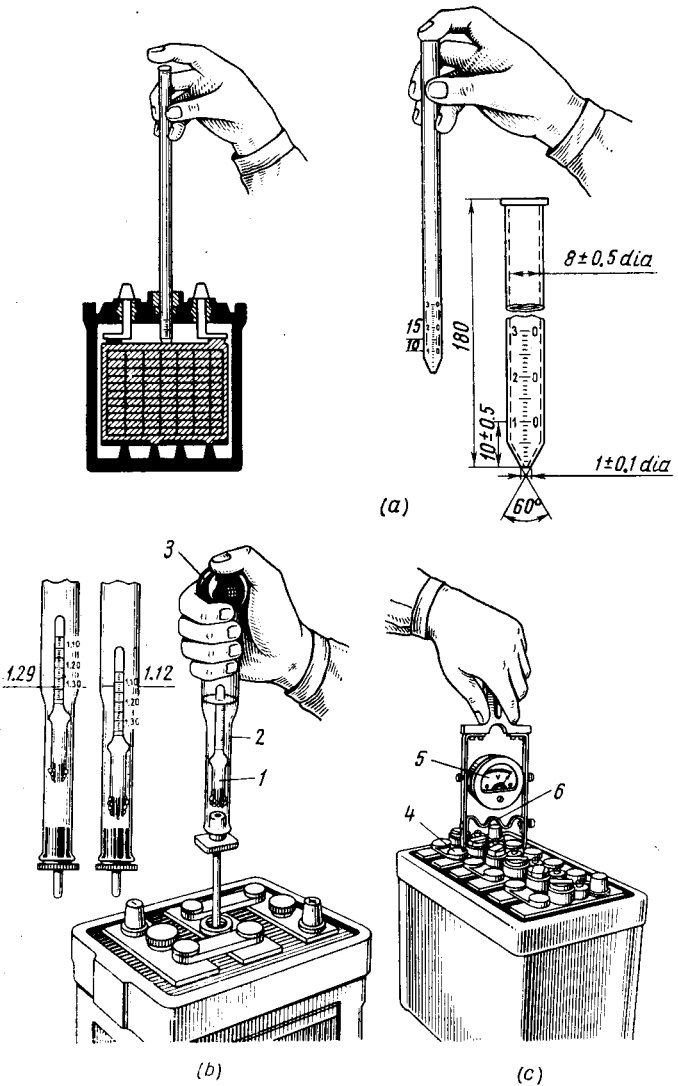

Fig. 60. Checking electrolyte level and state of battery charge
 (a) checking electrolyte level; (b) checking electrolyte specific gravity; (c) checking voltage of battery cells
 1—hydrometer; 2—acidometer; 3—rubber bulb; 4—terminal; 5—voltmeter; 6—resistors

and apply the corrections listed in Table 40 to obtain the exact value of the specific gravity.

Knowing beforehand the specific gravity of the electrolyte of a fully-charged battery, the state of charge of the battery can be determined from the data given in Table 41 by measuring the specific gravity and making the necessary temperature correction.

Table 40

Temperature Corrections of Hydrometer Readings

Temperature of electrolyte, °C	Correction	Temperature of electrolyte, °C	Correction
+60	+0.03	0	-0.01
+45	+0.02	-15	-0.02
+30	+0.01		
+15	0	-30	-0.03

Table 41

State of Battery Charge as Indicated by Specific Gravity of Electrolyte

Specific gravity in fully-charged battery	Specific gravity in discharged battery	Amount of discharge, per cent
1.310	1.270	25
	1.230	50
	1.190	100
1.285	1.245	25
	1.205	50
	1.160	100
1.270	1.230	25
	1.190	50
	1.140	100
1.240	1.200	25
	1.160	50
	1.100	100

The open-circuit cell and battery voltage may be measured with an ordinary voltmeter.

The on-load voltage of each cell should be measured with a cell voltage tester. Prior to this measurement, do

not forget to turn the vent plugs fully into the battery filling holes. Press one leg of the voltage tester against the terminal post and bring the second leg in contact with the second terminal of the cell being measured. Keep the tester legs pressed against the cell terminals for about five seconds and then note the readings of the tester voltmeter. The on-load voltages of the cells of a serviceable battery should differ from one another by not more than 0.1 V.

To avoid damaging the cell plates, the on-load voltage should be measured only for cells in which the electrolyte has a specific gravity not lower than 1.20.

On obtaining cell voltages below 1.3 V, the battery should be considered as defective and disassembled for inspection and repair.

Cell voltages above 1.3 V indicate that the battery is fit for further service and must be charged. The condition of the battery may be determined by comparing the results of measurements with the data presented in Table 42.

Table 42

**State of Battery Charge as Indicated
by Cell Voltage**

Reading of cell tester voltmeter, V	Amount of discharge, per cent
1.7-1.8	0 (fully charged)
1.6-1.7	25
1.5-1.6	50
1.4-1.5	75

Leakage of electrolyte, internal short circuits, and breaks necessitate disassembly and repair of the storage battery.

After charging the battery, check the specific gravity of the electrolyte and the on-load voltage of the battery cells once more. If the voltage of even a single cell is found to be below 1.6 V, the battery should be considered as defective and set aside for disassembly and repair.

Prior to repair, discharge the battery down to a final discharge voltage of 1.7 V per cell making use of a 12-15 A wire-wound rheostat, switchboard ammeter and voltmeter (Fig. 146), or the KH-1093 volt-ammeter.

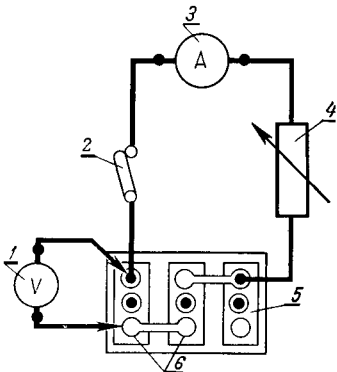

Fig. 146. Battery discharge circuit:

1—voltmeter; 2—knife switch; 3—ammeter; 4—rheostat; 5—discharged battery cell (disconnected from discharge circuit); 6—battery cells being discharged

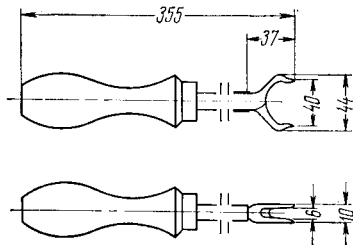

Fig. 147. Three-pronged cutter for removing sealing compound

During this discharge, the metallic impurities which may have got into the cell together with the electrolyte and been deposited on the negative plates by charging currents are returned to the electrolyte.

Drain the discharged battery of electrolyte. The drained electrolyte is unfit for further use. Fill the battery with distilled water up to normal level and charge at a rate of 0.1 nominal capacity for at least 15 to 16 hours. This lessens possible sulphation of the cell plates, produces lead peroxide in the active material of the positive plates and sponge lead on the negative plates.

If the container is cracked and individual cells are found to be shorted, disassemble the battery without charging, remedy the shorted plates, and charge the repaired bank in another sound container.

After charging the storage battery, drain the container of electrolyte, wash the cells with distilled water, wipe the battery dry with a clean cloth, and place it on a work bench for disassembly.

Remove the intercell connectors by making a circular cut around the cell terminal pins with a hollow cutter and brace as shown in Fig. 26, the terminal pins being left for further use. Remove the sealing compound with the aid of an electric soldering iron or the electrically heated three-pronged cutter shown in Fig. 147. Take the plate banks out of the battery container either by means of a special puller

(Fig. 148) the gripping end of which is introduced into the filling hole of the cover, or making use of twin tongs.

Do not pull the handle of the puller too strongly, as this may cause damage to the battery cover if the sealing compound has not been fully removed.

Rest the plate banks for two to three minutes in an inclined position so as to drain them of remaining electrolyte and then cut off the terminal posts of the extreme banks of the battery.

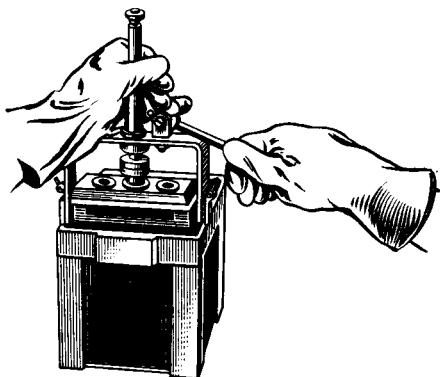

Fig. 148. Removal of plate bank from battery container with puller

Remove the cell covers and take the banks apart into positive and negative groups of plates.

Wash each group containing active material separately with running water for 10 to 15 minutes or by immersing it for 25 to 30 minutes in a tank filled with water. Clean the bottom of the battery container of deposited sludge with a wooden stick and rinse the container thoroughly with water.

Clean the cell covers of all remains of sealing compound with a scraper, then wash and dry the covers in open air.

Wash dry plastic separators and protective perforated plates which are found to be in good condition.

Cut the negative plates away from the straps with a hack-saw, leaving the plate lugs intact.

Discard plates having damaged grids, cracked and dislodged active material, and those showing deeply penetrat-

ing sulphation. Slightly sulphated plates can be remedied by scraping their surface with a wire brush.

Press the negative plates set aside for further use by wrapping the plates in newspaper, stacking them, placing the stack between two 5-mm thick metal plates and applying a pressure of 3 to 3.5 tons for 30 sec by means of a hand press. This is done to press protruding active material back into the grid.

Replace positive plates unfit for further service.

Cast new straps and intercell connectors of the same alloy and to the same dimensions as the old ones.

Build-up plate lugs by lead-burning in special moulds. After washing, test the tightness of containers free of punctures, bulges, or any noticeable cracks or pits.

Cracked containers may be reconditioned. To do this, wash the damaged container thoroughly with a 10 to 15-per cent solution of sodium hydroxide for three to four hours, then rinse it with clean water and dry.

Bevel both sides of the cracks to an angle of 120° , drill holes 2 to 3 mm in diameter at both of its ends, and scrape or sandpaper the area around the crack. Then degrease the cleaned area with acetone and dry the container, positioning it so that the crack lies in a horizontal plane.

Use the acid-resisting polystyrene inserts of K-marked battery containers to make up the filling compound. Dissolve pieces of polystyrene in ethyl acetate or KP-36 solvent in an enamel ware or aluminium vessel provided with a tightly fitting cover, using one litre of the solvent per insert. Stir the compound after three to four hours with a wooden stick so as to obtain a homogeneous mass and apply the compound. Dry the filling for six to eight hours at a temperature of 15 to 20°C and then apply the compound to the opposite side of the container. After 24 hours, test the container for leaks and hand it over for assembly. "Isonite", carbinol adhesive, molten polyvinyl chloride, and epoxy resins may also be used for filling cracks.

Select plates of the same quality (i.e., either formerly used, reconditioned, or new) for stacking the positive and negative groups of plates, as employment of new and old plates (at different potentials) in one and the same cell produces local equalizing current and high standing losses.

Lead-burn the plates into positive and negative groups as shown in Fig. 149. See that the plates are strictly paral-

led to one another. The plate lugs protruding from the template rack by 3 to 5 mm should be scraped bright with a wire brush and clamped in the mould fork in which the lead strap is inserted.

Lead-burn the plates with an electric carbon soldering iron supplied from a 6- or 12-V storage battery or step-down transformer. Fit a dia 5 to 6 mm carbon electrode in the electrode holder and connect it to the positive terminal post of the storage battery, the template being connected to the terminal post of negative polarity. Such a connection prevents oxidation and ensures a reliable joint.

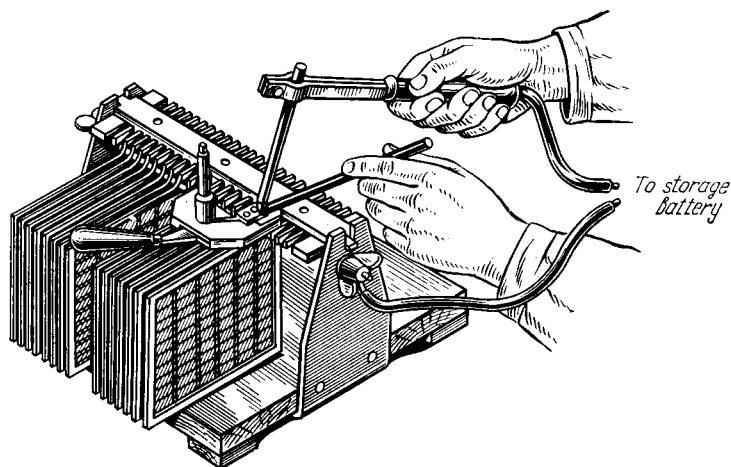

Fig. 149. Lead-burning positive and negative plate groups

Assemble the bank of cell plates in such a manner as to have it flanked by negative plates with the ribbed surfaces of the separators facing the positive plates. The assembled bank should enter the battery container with a certain effort. If this cannot be done by hand, the bank may be forced in by clamping it in a suitable press or vise. If the fit is loose, place additional separators between the bank of cell plates and the wall of the battery container. The terminal pins of neighbouring banks should be of different polarity.

On setting the protective plates and covers of the battery cells in place, fit the intercell connectors on the cell

terminal pins and lead-burn the pin, intercell connector, and cover bush together with an electric carbon soldering iron. After that, build-up the battery terminal posts on the pins as shown in Fig. 150 with the aid of a special mould. The filling rod used for lead-burning should be made of the same alloy as the lead parts of the storage battery. Punch “+” and “-” polarity marks on the terminal posts of the storage battery.

Fill the grooves between the cover and wall of the storage battery first with a thick sealing compound heated to 120°C and then top it with a thinner compound having a temperature of 180 to 200°C.

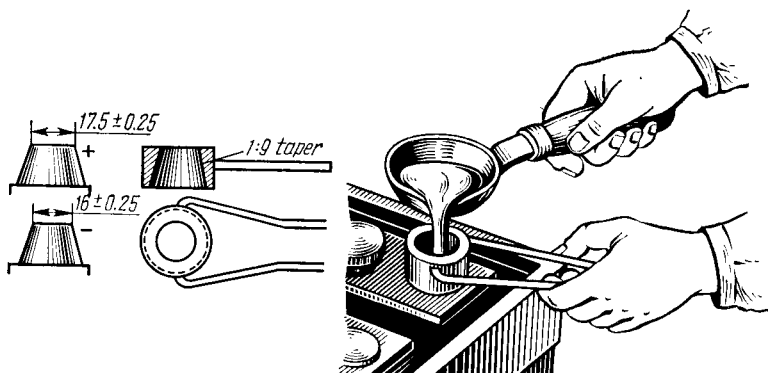

Fig. 150. Building-up terminal posts

The sealing compound should consist of 73 to 78 per cent No. 5 asphalt and 27 to 22 per cent MK-22, MC-20, or MC-14 oil. Prepare the compound by placing small lumps of bitumen in a bucket, adding a half of the oil, melting the mixture at a temperature of 180 to 200°C, stirring and keeping the mixture at this temperature for 40 to 60 minutes. Add the remaining amount of oil and heat the mixture with stirring for 1 to 1.5 hours. The old sealing compound may be used again after it has been neutralized in an alkaline solution, washed with water, and remelted.

The electrolyte should be made up by pouring clean distilled water into a clean ceramic or plastic vessel and then slowly adding the required amount of chemically pure sul-

phuric acid with a specific gravity of 1.84 in a thin and uninterrupted stream from a measuring glass or earthenware jar, mixing the solution continuously with a clean glass stirring rod.

It is to be kept in mind that water should never be poured into the acid; the latter will splash violently and may cause serious burns.

The distilled water is obtained from distillers included in the set of instruments, tools, and accessories for maintenance of storage batteries. The Д-1 electric distiller used for this purpose produces 4 to 5 litres of distilled water per hour at a power consumption of 3.5 kW, and the ЭДП-1,5 distiller—1 to 1.5 litre per hour at a power consumption of 1.5 kW. The distillers are meant for connection to 127 and 220 V a.c. supply mains.

Cool the electrolyte to surrounding temperature, measure its specific gravity and add sulphuric acid or distilled water according to requirements. The specific gravity of the electrolyte used for initial filling of the cells should be as stipulated in the battery operating instructions.

The quantity of sulphuric acid required for obtaining an electrolyte of various specific gravities is indicated in Table 43.

Table 43

Content of Acid in Battery Electrolyte

Specific gravity of electrolyte at 15°C	Content of acid per litre of electrolyte		Specific gravity of electrolyte at 15°C	Content of acid per litre of electrolyte	
	cm ³	g		cm ³	g
1.10	85	158	1.21	188	346
1.11	95	175	1.22	197	364
1.12	104	191	1.23	206	382
1.13	112	207	1.24	217	400
1.14	121	223	1.25	226	418
1.15	130	239	1.26	236	435
1.16	140	257	1.27	246	454
1.17	149	275	1.28	256	472
1.18	158	292	1.29	266	490
1.19	168	310	1.30	277	510
1.20	178	328	1.32	298	548

Pour the electrolyte into the battery cells with the aid of a glass funnel and let it soak in for about three to six hours.

Before charging the battery, check the level of electrolyte in all the battery cells and note the specific gravity and temperature of the electrolyte. Charge batteries having an electrolyte of normal specific gravity and a temperature of not over 30°C. Screw out the vent plugs for escape of gases released during the process of charging.

Charge the battery by connecting its positive and negative terminals to the respective terminals of a rectifier or some other source of d.c. supply and adjust the charging current to the value specified in Table 44. Keep the charging current at the specified level until gassing begins and a voltage of 2.4 V per cell is obtained. Then continue the charge at a current twice as small until the specific gravity and the cell voltage attain maximum value and no further increase occurs in the course of the last three hours of the charge.

The temperature of the electrolyte during charging should not rise above 45°C. At higher temperatures, discontinue the charge to cool the battery.

In the initial stage, measure the specific gravity and temperature of the electrolyte, as well as the cell voltage every three to four hours. The process of charging usually lasts from 12 to 20 hours.

On noticing any changes in the specific gravity of the electrolyte, add distilled water or electrolyte with a specific gravity of 1.4 to obtain the required value and then charge the battery for an hour to mix the solution. The electrolyte should cover the top edges of the cell plates by 10 to 15 mm.

After the initial charge has been completed, discharge the battery down to a final voltage of 1.7 V per cell and determine the ampere-hour capacity of the battery, multiplying the discharge current in amperes by the discharge period in hours.

Maintain the discharge current at a constant level by adjusting the resistance of the load rheostat correspondingly.

After repairs, the battery capacity should be not lower than 85 per cent nominal value.

On completing the second charge and checking the spe-

cific gravity of the electrolyte and the cell voltage once more, the battery can be put into service or handed over for storage.

In cases when the active material of the positive plates is considered unsuitable for further use, it is recommended that prior to assembly the battery be discharged to a final voltage of 1.7 V per cell. This is done to prevent conversion of the sponge lead on the negatively charged plates into lead hydroxide on contact of the electrolyte-moistened plates with the oxygen of the surrounding atmosphere. The above chemical reaction is irreversible since the lead hydroxide subsequently reacts with the sulphuric acid and becomes finally converted into large crystalline masses of lead sulphate. Therefore, the groups of negative plates should be thoroughly rinsed with distilled water on disassembling the battery.

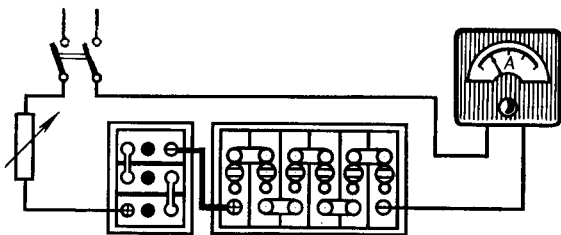

Fig. 151. Battery charging circuit

When charging several batteries at the same time, connect them in series as shown in Fig. 151. The number of batteries that can be placed on charge in this manner depends on the charging source voltage which should not be below the sum of the battery voltages on terminating the charge (i.e., on attaining 2.7 V per cell). The charging current specified by the battery manufacturer should be maintained throughout the process of charging.

The batteries placed on charge at the same time should be of equal capacity.

As an example, let us consider how many batteries can be charged at the same time by the type BCA-5 rectifier which has a maximum output voltage of 64 V d.c.

At a maximum voltage of 2.7 V per cell, this rectifier is capable of charging $\frac{64}{2.7} = 24$ cells at the same time and,

in consequence, eight 6-V or four 12-V batteries of equal capacity can be put on charge.

The storage batteries should be kept in dry premises away from exposure to sunlight. New batteries not filled with electrolyte should be kept at ambient temperatures not lower than 0° and not higher than plus 35°C .

Damp surroundings promote sulphation of cell plates, whereas sun rays are injurious to plastic containers and shorten the service life of the battery. Keep new batteries on shelves with the terminal posts directed upwards. The battery vent plugs should be furnished with rubber sealing gaskets and tightly screwed in. Coat the terminal posts with commercial-grade vaseline to prevent corrosion.

Batteries with separators made of microporous plastic or ebonite may be kept in unheated but dry rooms at temperatures as low as minus 25°C .

Dry batteries with wooden separators can be kept in storage for one year, and those with microporous plastic or ebonite separators—for two years.

Batteries taken out of service should be kept in fully charged condition in a cold room at temperatures not higher than 0° and not lower than minus 25°C . Within this range of temperatures, the standing losses are low, irreversible sulphation of cell plates and loss of capacity will not occur, and the battery service life is not shortened. This, however, applies only to quite serviceable batteries which have passed the load test and are filled to normal level with electrolyte of normal specific gravity. It is inadvisable to increase the specific gravity above normal value in order to prevent freezing of the electrolyte, as such an increase causes rapid deterioration of the positive plates and wooden separators.

To prevent leakage and freezing of the electrolyte, wipe the outer surfaces of the battery dry with a clean cloth and measure the specific gravity and level of electrolyte once a month.

The battery department should have a dressing room furnished with wash-stands and lockers for keeping clothes and overalls; the battery repair and charging room should be provided with wash-stands, small tanks filled with a 10-per cent aqueous solution of sodium bicarbonate or aqueous ammonia, and a medicine chest with tincture of iodine, cotton wool, sterile gauze, and individual packs of sterilized bandages.

A chemical (tetrachloride-base or dry-powder) and a carbon dioxide fire-extinguisher should be at hand near the entrances of the rooms for fighting an outbreak of fire.

Electric shock hazards are most likely to occur when working on live equipment, on dealing with defective insulation or coming into accidental contact with energized parts, either directly or through some metallic object.

A fundamental safety requirement is that live parts of electrical equipment be reliably insulated and guarded to prevent electric shock.

Batteries

Lead Acid

WARNING - FIRE HAZARD

A Low voltage power supply is just as likely to cause a fire if a short circuit occurs as with any other voltage. Please use suitable fuses or circuit breakers near the battery and between the battery and any other power sources. Also ensure that electrical conductors such as metal objects cannot accidentally fall across the battery terminals.

Exploding Battery: Batteries generate explosive gases during operation and when charging. Flames, sparks, burning cigarettes or other ignition sources must be kept away at all times. Ensure that there are no loose metal objects around the batteries that can be blown down by a strong wind or knocked onto the battery terminals. Similarly sparks can be generated at the battery due to a poor connection.

Always shield eyes when working near batteries. Battery charging should be carried out in a well ventilated area - never in a closed room. Always turn battery charger off before disconnecting a battery.

BATTERY SAFETY

Battery acid can cause burns. Use extreme care when handling acid. If electrolyte is spilled or splashed onto clothing or the body, wash with water and neutralize with a solution of baking soda and water. Electrolyte splashed into the eyes is extremely dangerous. If this occurs, force eyes open and wash with clean cool water for five minutes and call a doctor. A solution of 1 tablespoon of bicarbonate of soda to 1 pint of water should be kept readily available and in view near the battery bank. This solution will neutralize the acid and hence be a more effective eye-wash in the event of such an accident.

BATTERY ACID

Otherwise referred to as electrolyte. The water used for diluting acid and for topping up must be free of mineral impurities. Distilled water, demineralized water, or rain water may be used. Never use tap water as the effect of impurities is cumulative and detrimental to the battery.

NOTE: Do **NOT** add battery acid to the battery unless under the specific directions of a battery technician.

Placement of Batteries

Place batteries on a firm, solid and level support. Weight of batteries should be equally distributed over the base area. Batteries should not be in direct contact with a cold surface such as concrete. If the base of the battery stays cold, the acid will not mix readily and will tend to stratify (most concentrated acid at the bottom and least concentrated at the top). It is recommended that you use an insulating material such as rubber or vinyl under the batteries that will not be affected by the corrosive properties of battery acid.

Battery Connections

Make as few connections directly to the battery as possible. It is desirable to have a fully fused Control Board from which all other connections can be made.

Before making your connection to the battery, first smear petroleum jelly (eg Vaseline) over the terminal post to prevent or reduce the likelihood of battery acid creeping up the terminal post and rapidly corroding your connector.

Make sure that the connector is fixed very firmly and that it is making good contact with the terminal post to reduce voltage drop.

Do not increase your battery capacity by connecting several small batteries in parallel. The more parallel connections there are, the more prone the system is to uneven charging due to lazy cells and unequal cell characteristics. This will cause an overall reduction in expected battery life and increase maintenance requirements.

**DO NOT LIFT BATTERY
BY TERMINAL POSTS**

Care of Battery

Cycling of Batteries

The life of a battery is related to how many times and how deeply it can be cycled (charged and discharged). A cycle is defined as one charge, to fully charged, and one discharge, to almost fully discharged. An 80% discharge is regarded as 'deep'. However, for maximum life, lead-acid batteries should be discharged as little as possible. We recommend that your average cycle should be no deeper than about 20%, and never beyond 50%.

A standard car battery can only take about twenty deep discharges before it becomes completely useless.

If you have an all year round hydro potential then you may get away with only a very small battery bank (equal to your daily usage) because the battery bank is getting charged 24 hours per day. If you only have an intermittent flow, then a hydro system may be an excellent back-up for a solar power system.

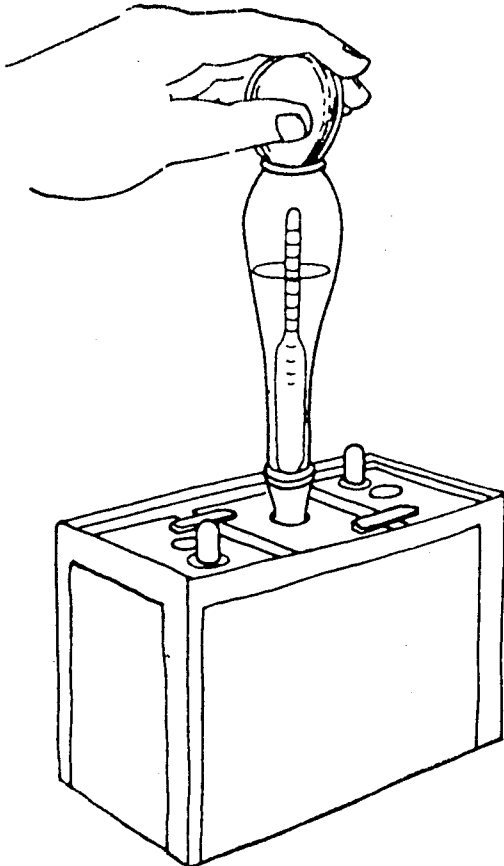

Testing specific gravity of a battery

1. Visual inspection: Check electrolyte level at least once a month. If the batteries are fully charged and still charging, water loss may increase. It is advisable that a suitable charging regulator be installed to prevent overcharging of the battery. Overcharging is indicated if the battery is bubbling vigorously.
2. Hydrometer Test: Check the electrolyte level, to ensure that it is above the plates in all cells.

If it is below the plates, the test cannot be carried out until water is added and the battery charged to mix the water and residual acid in the battery. It is important to ensure that the plates do not remain exposed to air and allowed to dry and oxidize (see notes on page 32).

The state of charge of each cell can be measured with a hydrometer to determine the specific gravity of the electrolyte (specific gravity is its weight compared to water).

Using Hydrometer

Draw the acid into the hydrometer, so that the float is lifted free and not touching the top or the bottom. The barrel must be held vertically and the eye level with the surface of the liquid. Disregard the curvature of the liquid against the glass.

Generally the battery state of charge is as follows:

SG (25°C)	Volts	State of Charge
1.260	6.32 / 12.65	100%
1.220	less than 6.22 / 12.45	75%
1.180	less than 6.10 / 12.20	50%
1.120	less than 6.00 / 12.00	Discharged

Cell temperature corrections should be applied if accurate readings are required. 0.004 points should be added or subtracted for each 5°C +/- variation from 25°C.

3. Voltage Test: Voltage readings should be taken whilst the batteries are neither charging nor discharging (nothing connected and turned on). Immediately after either charging or discharging the battery voltage may not have stabilized. The voltage will settle down in about 30 minutes after charge or discharge are discontinued.

The Rainbow Power Company can supply you with battery connectors, control board, fuses, suitable electric cable, charging systems etc. Do not hesitate to contact us for more advice, information, service etc.

Effect of Electrolyte Temperature on Battery Capacity

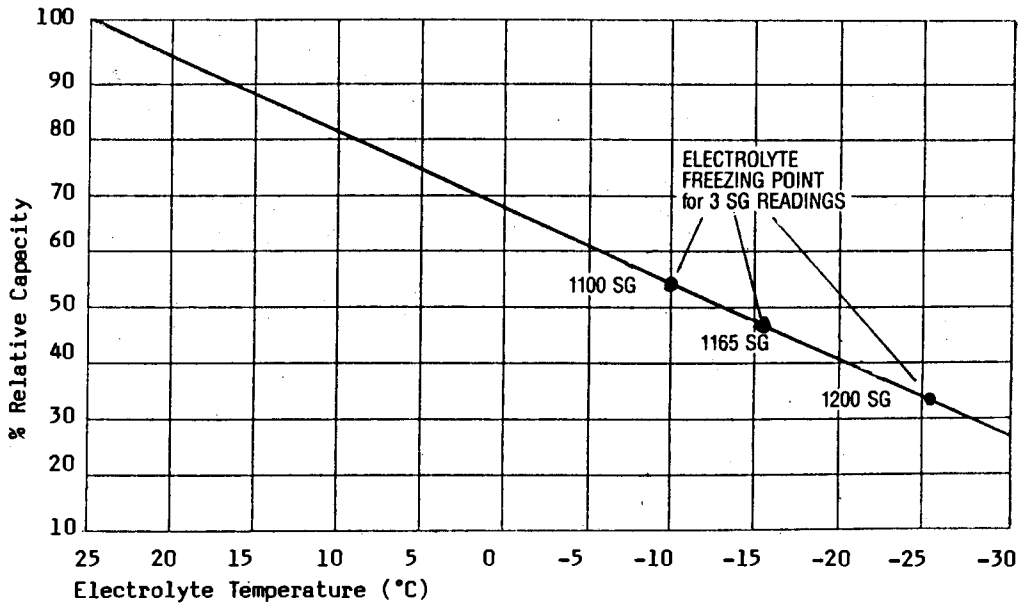

Power Supply Batteries

What Type and Size of Battery?

For power and lighting purposes (eg in a home situation) it is recommended that an appropriately sized Deep Cycle Battery Bank be used. Vehicular batteries (other than traction batteries) are usually not Deep Cycle Batteries and are not appropriate for a house power supply system.

The size of the battery bank may be determined by the size and expected usage patterns of the overall electrical installation. Both the size of the battery bank and the limitations to the user of the power supply must in turn be determined by the size of the charging system and the frequency of charging.

It is not advisable to increase the battery bank by putting several batteries in parallel. A 12 volt battery does however consist of six 2 volt cells in series to make the required 12 volts. What we are saying here is to avoid adding several smaller 12 volt banks to each other to make up a larger one, it makes for a much more complex monitoring system and could mean that you do a lot of damage to the entire battery bank if just one 2 volt cell breaks down. More storage should be attained by acquiring a larger battery bank, and not by adding small ones in parallel.

Above 200 Amp-Hours you will find that the bank will consist of either two 6 volt units connected in series or six 2 volt units connected in series. With the individual 2 volt cells, if there is a problem with one cell it is only a matter of replacing it without having to replace an entire battery. By not having one battery bank connected in parallel to another battery bank, you will not have damaged one battery bank by discharging it into a dead cell of the other bank.

Battery Bank Size - Amp Hours

The amount of potential electricity stored in a battery is measured in Amp-Hours (AH). For every 100 Amp-Hours of battery storage you will need the equivalent of at least 60 watts of Solar Panel. For photo-voltaic installations, about 5 days storage capacity to reach a 50% discharged condition is usually recommended.

We suggest that you have a battery storage capacity of 10 to 15 times your daily use for solar or wind charging and 5 to 10 times for generator charging. The size of both the battery bank and the charging system may be dictated by the size of the inverter you wish to run, particularly if the inverter is a large one (eg over 600 watts).

Battery Bank Size - Voltage

The most commonly used voltage is 12 volts. There is quite an extensive range of lights and appliances available for this voltage. Higher battery voltages (usually multiples of 12) are used:

- If only 240 volts is required via a large inverter (ie over 1200 watts)
- If long cable runs and high currents are required

Although 32 volt systems were once common, this voltage is now gradually being phased out.

To plan a power system to suit your budget we invite you to discuss it with one of our staff.

INSTALLATION

The following points must be heeded when installing your battery bank:

1. Lead Acid Batteries should be installed in a cool well ventilated area, well away from any source of heat and from windows admitting direct sunlight.
2. Open stands should allow access from both sides for maintenance and cleaning.
3. Always keep cells upright to avoid damage or displacement of plate assemblies.
4. Never lift cells by the terminal lugs; large cells may be lifted by their handles (if fitted) or by means of a sling made of plastic sheeting.
5. Cells must be placed on a flat surface for even weight distribution, and should never be rested on the edges of packing cases etc.
6. Levers of any kind must not be used to position cells, instead a cell must be lifted bodily and lowered gently into position.
7. Never slide a battery across a floor; this particularly applies to those with acrylic cases.
8. When batteries are installed in cabinets, adequate ventilation must be provided to avoid a dangerous concentration of hydrogen. Cabinet doors should be open during gas charging.
9. Stands should provide support for at least 50% of the base area. It is recommended that timber supporting rails should be covered on top and sides with rubber or PVC at least 1/16" thick.
10. No metal should be in contact with plastic cell containers.
11. Battery connection links should be kept as short as practical, terminals should be cleaned and the connecting lugs firmly tightened using stainless steel bolts - do not over tighten. Grease-impregnated felt washers should be placed under the lugs to arrest corrosion. The interconnecting lug faces on Telecom type batteries must be cleaned, and if necessary squared with a coarse file. The lugs are bolted together, the lug, bolt and nut being lightly coated with petroleum jelly before assembly. The correct size spanner must be used; pliers or grips must not be used or damage may result. Nuts must not be over-tightened.
12. During normal battery life, positive plates may expand and increase in length by 5%. Intercell connections must therefore be soft lead or flexible. Heavy bus bars or charging leads must be able to accommodate some movement.

MONITORING AND MAINTENANCE

A battery bank will need to be monitored and will need a certain amount of attention from time to time. First of all, a battery bank must be charged and remain as fully charged as possible. It is advisable, in a home power situation that you have an amp-meter to show the rate of charge and a volt-meter to give some idea of the state of the batteries. Both of these meters should be mounted in such a position that they are noticed frequently. This strategy will make you more familiar with what to expect and make you aware of a problem when it arises, such as no amps showing when the batteries are supposed to be charging.

You will need to take note of the rate of water loss of the battery bank and make sure it is topped up before the level drops to less than one centimeter above the plates or to the lower level marked on some batteries. Bring it to the bottom of the filler wells or to the upper (high) level specified by the manufacturers. Only top the battery up with distilled water or clean rain water collected in plastic or glass. Do not over-fill. It is advisable to take specific gravity (SG) measurements of all the cells of the battery bank once in a while with a hydrometer (see page 33).

CHARGING THE BATTERY

The word "gas" here refers to a gas given off by the acid due to electrolysis of the water. If continued at a high rate this gassing can be quite a violent boiling action and will result in loss of water and plate damage.

These points must be born in mind:

1. If a battery is left in a partially discharged state for an extended period, sulphation of the plates will occur, which if allowed to proceed, results in irreversible loss of capacity.
2. If a cell is maintained at a constant voltage without any cycling, "stratification" of the electrolyte into layers of differing densities will occur. This can be minimized by occasionally charging the battery to a gassing voltage (ie some bubbling occurs).

CHARGE LEVEL OF BATTERY

The charged or discharged condition of a lead-acid battery is indicated by the colour of the positive plate*, the voltage, and the strength (specific gravity) of the electrolyte.

* see page 37 for definitions

Specific Gravity

The hydrometer measures the Specific Gravity (SG) of a battery. You will find that the electrolyte in the hydrometer tends to curve up at the edges against the glass. This curvature is referred to as a meniscus. The SG reading should be taken from the bottom of the meniscus.

The SG is a measure of the concentration of the acid in a battery. Due to chemical action caused by charging and discharging, the proportion of sulphuric acid (SG = 1.8) to water (SG = 1) in the electrolyte and therefore, the SG of the electrolyte, gradually increases during charge and decreases during discharge.

The complete working range of SG lies between the limits of 1.1 and 1.3. If below 1.1, damage may be caused by the plates becoming hydrated, while if above 1.3 the plates and separators are liable to be corroded.

The SG of the electrolyte of a fully charged battery is between 1.215 and 1.28, depending on the battery type. When the SG falls to about 1.175 the battery is considered to be discharged and needs charging.

The SG is often multiplied by 1000 and the hydrometer scale marked accordingly. SG readings should be referred to a temperature of 25°C. A temperature that is significantly at variance with this temperature will cause a change of viscosity of the electrolyte and needs to be taken into account when the SG is measured. Refer to the SG versus temperature graph. A significantly lower temperature will also cause a sluggishness of the battery.

Owing to the time required for the diffusion of the electrolyte, the change in SG lags behind the charge or discharge by an amount which depends on the characteristics and dimensions of individual cells and the rate of charge or discharge. Consequently, the SG will continue to rise for a short period after the charge has been terminated and similarly may continue to fall after a discharge has been terminated, although, if the end of the discharge is at a low rate the lag may not be noticeable.

Only add distilled water to the electrolyte. Do not add acid, unless under the instruction and supervision of a Rainbow Power Company Battery Technician. Do not add water with impurities as these impurities will be accumulative over time and will cause problems. Do not take a SG reading just after topping up with water.

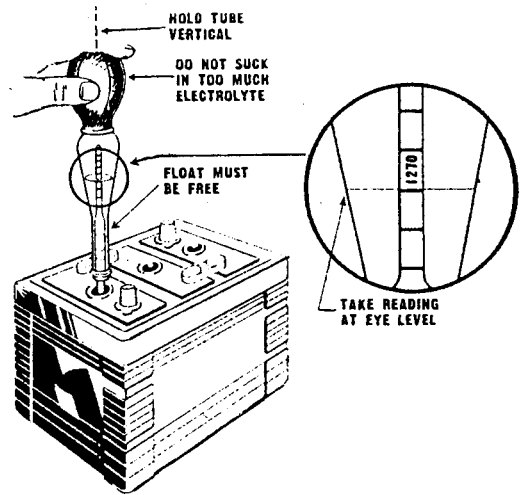

Checking specific gravity of battery with hydrometer.

How to use a hydrometer to check the specific gravity of a battery.

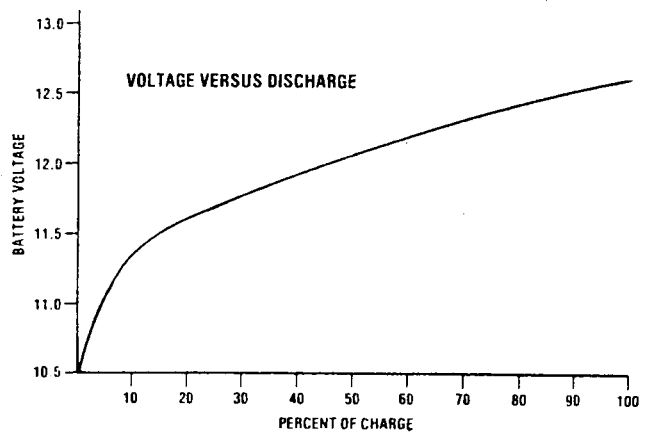
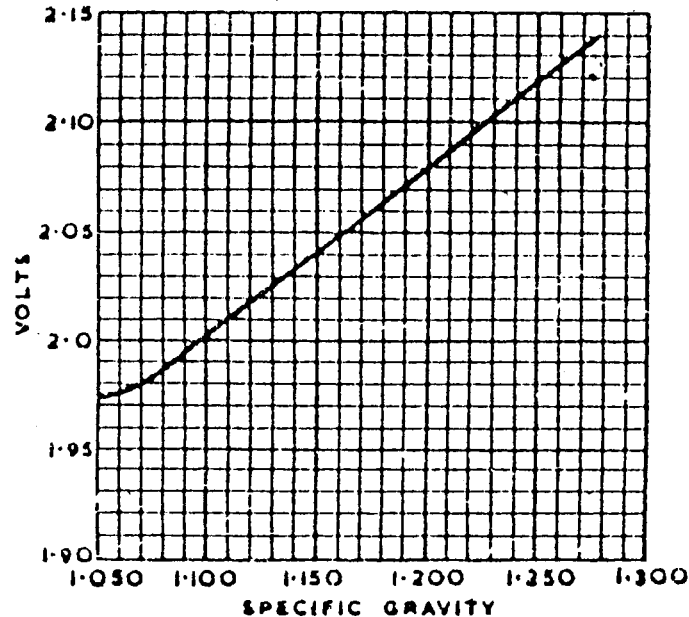

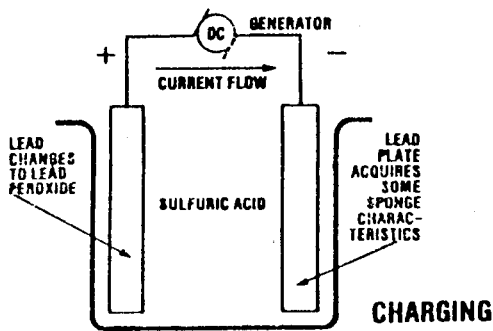

Discharged Battery

If a battery is left standing in a discharged condition for any length of time, the sulphate from the sulphuric acid combines with lead and forms lead sulphate which hardens on the negative plates. This compound becomes increasingly harder and more crystalline in composition and becomes increasingly more difficult to be broken down by charging. In the process the lead sulphate also expands and buckles the plates which in turn can cause irreparable damage to the battery.

Batteries in this condition are referred to as "sulphated". If they are neglected for too long, they are useless and can be discarded. If it hasn't been left too long, a sulphated battery can be brought back into service by a constant slow charge over a long period of time. Fast charging a badly sulphated battery will probably ruin it.

Some tell tale signs of a sulphated battery are a gradual darkening of the negative plate accompanied by a white deposit on its surface whereas the positive plate changes to light brown sometimes under cover of a black scale which peels. The internal resistance of the battery increases resulting in a higher voltage on charge. As sulphation involves a reduction of the electrolyte concentration, never add acid to improve the density as this will only aggravate the condition.

Overcharging

Overcharging and boiling a battery is also damaging. Severe overcharging causes a lot of heat and gas. This may cause the plates to buckle, the separators to weaken and the water to evaporate. The bubbling action also causes active material to be shed from the plates, thereby decreasing the amp-hour capacity. The evaporation of the water can cause the plates to be exposed to the air and deteriorate due to oxidation.

During normal charging, the liberation of gas occurs to a very slight extent when the battery rises to about 13.8 volts, while normal gassing occurs when the voltage has risen to about 14.2 volts. While the initial release of gas from the plates is determined by cell voltage, the volume of gas is a function of the rate of charge. A violent bubbling action and a gradual temperature increase are warning signs that your battery is being overcharged.

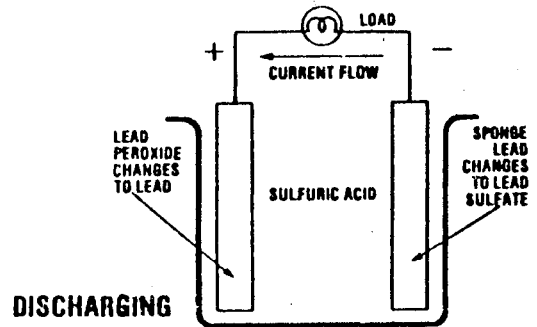

VOLTAGE REGULATION

It is advisable to install some kind of regulating device to prevent batteries from overcharging. The voltage at which the batteries may need to be regulated depends on several factors. These factors include whether you have a constant or periodic charging source. Solar panels, wind generators and petrol generators can all be considered as periodic charging sources, they may only be charging for a few hours each day or a few days in the week.

Under any regulated charge the electrolyte will, however, tend to stratify so that a boost charge should be applied at between one and six monthly intervals.

Boost charging serves to both stir up the electrolyte to overcome stratification, and to equalize the voltages between the cells. The highest and lowest cell voltages should not differ by more than 0.05 volts. A boost or gas charge will normally rectify any voltage variations.

The Rainbow Power Company sells a range of regulators. We invite you to contact our staff to discuss with you and design a suitable power system to meet your requirements and then to advise you on the operation and maintenance of that system.

Cycling

Cycling is the process of partially discharging a battery and then charging it back up to full or nearly full charge. This may be a manual process or it may be carried out by a charger which automatically cuts in and out at predetermined cell voltages. It may be "shallow" or "deep".

It is preferable to cycle a lead-acid battery bank as "shallow" as possible. Even though you are using a Deep Cycle Battery its life expectancy increases as a result of not cycling it too deeply. You should never discharge your battery by more than 50% in the worst instance and stay within 10% to 20% during average daily operating conditions.

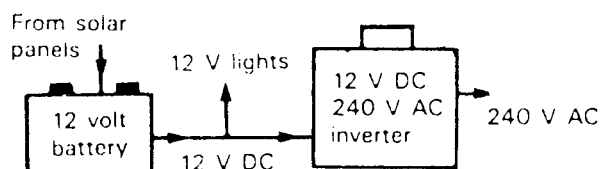

A lead-acid battery will self discharge over a period of time if left standing and not connected to any charging source.

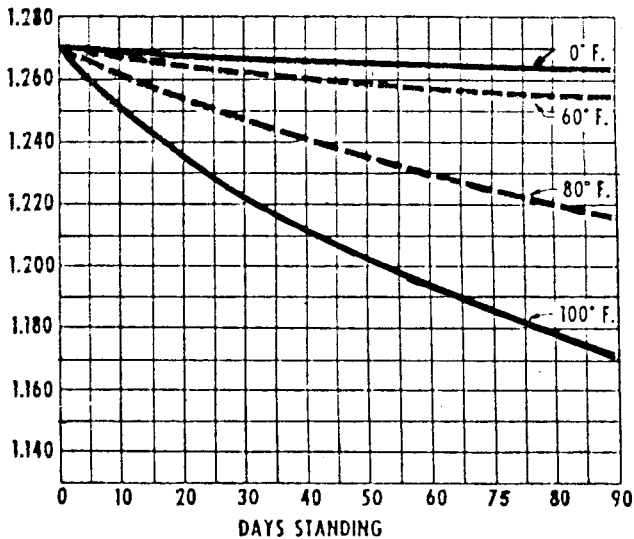

BATTERY CARE CHECK LIST

1. Keep battery clean and dry - dampness lets electric current leak away.
2. Keep vent plugs in place to stop dirt falling into cells.
3. A thin coating of petroleum jelly will keep all terminals and connections free from corrosion.
4. For topping up the cells, use either distilled water or clean rainwater preferably collected in glass or plastic. Never top up the battery with anything other than distilled water or rainwater. Do not top up battery with acid, unless on the advice of a Rainbow Power Company Technician.
5. Make sure that the positive and negative plates inside the battery are covered with electrolyte at all times. Do not overfill.
6. Avoid adding water to a battery just prior to taking a SG reading, as the reading will be misleading. If water has to be added, the battery should be charged for a while to mix it with the electrolyte thoroughly before the reading is taken.

Maintenance Schedule:

- | | |
|---|--------------|
| (i) Check SG of electrolyte | 1 month |
| (ii) Check level of electrolyte-top up if necessary | 1 month |
| (iii) After boost charge, check cell voltages. These should correspond to each other to within 0.05 volts | 1 - 6 months |
| (iv) Check tightness of terminals and remove corrosion if necessary | 6 months |

DO NOT: top up battery cell with water when the battery is in a state of discharge. If the electrolyte level is very low, top up only to make sure the plates are covered and no more. The fluid level rises with the charge level, so if water is added when the battery is discharged, it may overflow on charging and lose electrolyte.

DO NOT: "tap" into part of your battery bank to obtain lower voltages for running lower voltage appliances. You will damage the battery bank by discharging some cells in relation to the rest of the battery bank.

DO NOT: lift batteries by the lugs or terminals. Batteries need to be adequately supported from underneath.

DO NOT: go near the batteries with an open flame or cigarette. You may cause the batteries to explode.

DO NOT: overcharge your battery bank to the point of heating the cells up. This will cause internal damage. It is acceptable to charge to the point of the electrolyte bubbling. You may need to add water if the electrolyte level goes down.

DO NOT: install batteries in parallel if it can be avoided. To increase battery capacity you should endeavor to get a single bank of the required amp-hour capacity rather than smaller batteries hooked up in parallel. For example, six 2 volt cells connected in series to provide 500 amp-hours of capacity is preferable to two 12 volt, 250 amp-hour batteries connected in parallel. Batteries in parallel should either be protected or electrically isolated through the use of diodes or fuses. This will ensure that if one battery fails due to a shorted cell, the current rushing from the good battery to the defective battery does not overheat the conductor risking a fire. It will also save the charge and perhaps the life of the sound battery.

DO NOT: use alligator clips or other sprung jaw methods as sparking often occurs when they are removed or attached. Hydrogen gas is generated by batteries under charge which is very explosive in the presence of air. Sparking can ignite it. The resulting explosion will not only destroy the battery but also injure the person holding the alligator clips with flying debris and battery acid.

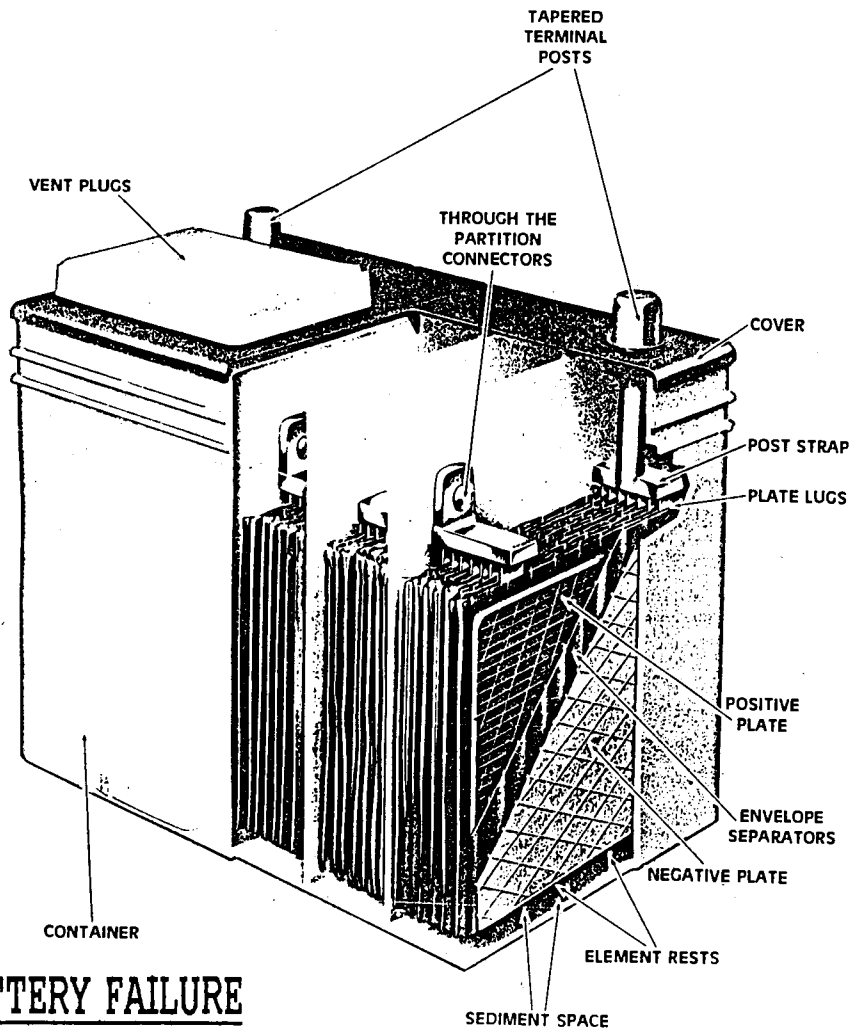

BATTERY FAILURE

The capacity of a battery indicates the ability of the battery to deliver an electric current at a given rate for a specified time. If the battery appears to have lost capacity it may be because it hasn't been recharged thoroughly, or it may be sulphated or else the battery may be approaching the end of its useful life.

A battery will lose active material from the plates due to frequent cycling, movement and vibration. This material will settle in the sediment chamber and thus ceases to play an active part in the battery's function. This results in a gradual loss of capacity throughout the battery's useful life.

A battery may stop functioning very suddenly if an internal short circuit is caused. Such a short circuit may be the result of the sediment in the sediment chamber coming into contact with both positive and negative plates. Otherwise it may be that the plates have come into contact with each other as a result of buckling of the plates or "treeing" between the plates. "Treeing" is the result of a very slow recharge rate (500 hours or more) when the spongy lead deposits on the negative plates in a "tree" like formation. This may eventually bridge the gap between the positive and negative plates.

Another possible cause of failure of a lead-acid battery is when the contacts between plates, straps, terminals and/or intercell connectors are broken.

Battery Replacement

If there are any signs that the battery bank is not performing well, first check whether the batteries are fully charged or not.

The battery probably needs replacement if:

1. one cell voltage is far below the others.
2. the battery fails to charge.
3. the battery fails to hold its charge or voltage.

An investigation by a Rainbow Power Company Battery Technician can determine whether the batteries need replacing. The battery age and usage pattern may give some clue as to the outcome of such investigation.

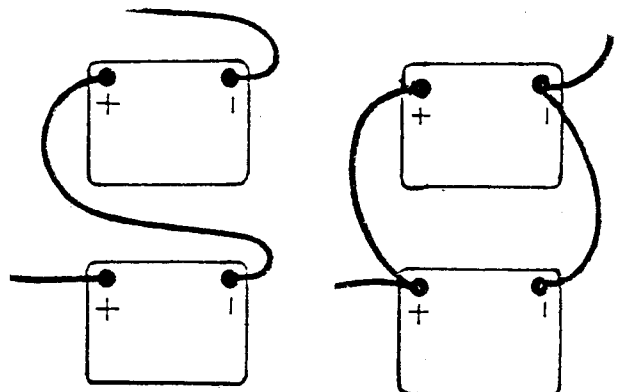

Series

Parallel

Definitions

Amps - is the measure of the flow rate of electrons through a conductor.

Amp-Hour - is the number of amps (charge or discharge) multiplied by the number of hours for which this charge or discharge continues.

Amp-Hour Capacity - is the number of amp-hours normally available from the fully charged state to the end of discharge (about 11 volts for a 12 volt battery). The standard discharge rate is either an 8 or 10 hour discharge.

Automotive Battery - (also referred to as Starting, Lighting, Ignition Battery) - a battery specifically designed for motor vehicles with many thin plates to provide a high current for a short period and yet be relatively small and light.

Boost Charge - is a recharge which takes place at a voltage higher than the normal floating voltage. Is also referred to as gas charge, refresher charge and equalizing charge.

Charge - is the process of chemical change when a battery receives and stores energy from a charging source.

Charge Rate - is the rate of chemical change of a battery expressed in hours (for a 100% charge)

Cycle Operation - is a method in which batteries are taken through a process of discharge and recharge.

Deep Cycle - is a working cycle in which the discharge proceeds beyond 50% of the 10 hour rate capacity.

Deep Cycle Battery - a battery designed to be able to cope with some deep cycling without losing too much amp hour capacity. One way of achieving this is by the utilization of a thicker pasted plate than is found in vehicular batteries.

Desulphation - is the treatment given to a sulphated battery. See Sulphation.

Discharge - is the process of chemical change when a cell delivers energy to the load.

Discharge Rate - is the rate of chemical change of a battery expressed in hours (for a 100% discharge).

Electrolyte - in the case of lead-acid batteries is a diluted solution of sulphuric acid which acts as the medium by which chemical change takes place between itself and the lead-plates with which it reacts during charge and discharge.

Equalizing Charge - is a process which brings all cells of a battery to a fully charged state by correcting small irregularities in the state of charge of individual cells. It is a form of boost charge with the intent of equalizing cell voltages.

Float Operation - is a method in which batteries are theoretically preserved in a fully charged state by maintaining all cell voltages above but close to the true open circuit voltage (OCV).

Gas Charge - is a boost charge which takes place at the end of a recharge and at a voltage above 14.1 volts for a 12 volt battery bank.

Headroom - liberated space in battery container above the normal acid level.

Open Circuit Voltage - The terminal voltage of a battery while at rest (neither charging nor discharging).

Plate - inside each cell of a lead acid battery are a series of positive and negative plates. All the positives plates are connected to each other and to the positive terminal of each cell, and likewise with the negative plates and the negative terminals. Between each alternate set of plates are non reactive plate separators.

Recharge - is the restoration of the battery to its maximum amp hour capacity after a discharge.

Sediment Space - The space between the bottom of the plates and the bottom of the container. Also referred to as footroom.

Shallow Cycle - is a working cycle which does not discharge beyond 50% of the 10 hour rate capacity.

Specific Gravity - is the ratio between the weight of equal volumes of a substance and pure water.

Sulphation - an undesirable process that takes place on the plates of a lead-acid battery as a result of the battery being left in a discharged or semi-discharged state for a long period of time, resulting in the seriously reduced capacity of the battery. Deep Sulphation may cause permanent damage or may be reverseable with an involved treatment.

Volts - is the force that causes electrons to flow between two points of a conductor. Also referred to as electromagnetic force (emf) and potential difference.

Watts - is a combination of volts and amps. With a 12 volt system, the wattage of an appliance is the amps used by the appliance multiplied by 12. With a charging system such as photo-voltaic solar panels which are rated in watts, your expected charge rate (in amps) may be as low as watts divided by 15 (instead of 12) because of the voltage differential between charging source and battery and the fact that a fully charged 12 volt battery may be in excess of 14 volts. Watts is a measure of power. Also referred to as volt-amps or VA.

Watt-Hours - is the same as amp-hours multiplied by voltage.

Wohin mit dem Strom?

Die Speicherung des gewonnenen Stromes bleibt der heikelste Punkt: 1. geben Batterien bei weitem nicht das ab, was man hineinpumpt, 2. ist die Batterie - Herstellung äußerst umweltschädlich. Kaufen wir Batterien, fragt sich, wie viele Jahre das Windrad nun Atomstrom sparen muß, um den Umweltschaden vom Batterie - Herstellen und "Entsorgen" wieder wett zu machen. Also nehmen wir lieber höhere Batterie - Verluste in Kauf und holen bzw. tauschen die Batterien gratis bei der Schadstoffsammlung.

Schön wäre es, den Strom direkt zu nutzen und gar nicht erst in Batterien verloren gehen zu lassen. Doch die Möglichkeiten sind bescheiden:

Wenn Du ein Gelände mit Riesen - Gefälle hättest, könntest Du ja mit dem Windrad Wasser in irgend einen großen Behälter vom Schrott pumpen und bei Strombedarf genau die nötige Menge durch eine kleine Turbine rauschen lassen, - für 99,99% der Windradbastler bleibt das Illusion.

Weil die Spannung vom Windrad ungeheuer schwankt, wenn keine Batterie dran ist, kann man ohne Batterie und direkt am Windrad nur Verbraucher betreiben, die das aushalten, z.B. zusammen mit einem Überspannungsschutz für die LiMa einen Elektromotor, der irgendwas mal langsam und mal schnell dreht. Aber wozu dann der ganze Aufwand? Das macht ein mechanisches Windrad doch viel besser!

Mit Elektrolyse kann man auch Wasserstoff und Sauerstoff herstellen und daraus bei Bedarf Knallgas machen und verbrennen - saubere, aber gefährliche Energiespeicherung, für echte Nutzung viel Sicherheitstechnik nötig.

Der einzige wirklich einfache Weg, ohne Batterien auszukommen, ist leider nur, den Strom zu verheizen. So einfach, daß ich nichts weiter darüber zu schreiben brauche. Jeder Elektriker weiß Bescheid. Aber wohin mit dem Strom im Sommer? Also doch Batterien...

Batterien richtig behandeln!

Kontrolliere den Ladezustand mit Voltmeter oder Säureprüfer. Nicht höher laden, nicht tiefer entladen, nicht entladen stehenlassen! (Werte für 12-V-Bleiakku)
Beim Laden bzw. Entladen messen, sonst falsche Werte! Mehr im Heft „Solarstrom“.

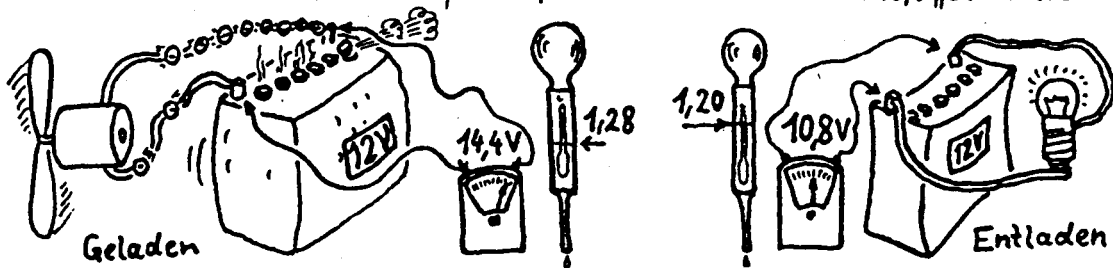

Die gewöhnliche Autobatterie, ein 12-V-Bleiakku, ist leer bei 10,8 Volt, voll bei 14,4 Volt. Höher laden und tiefer entladen schadet der Batterie schon nach kurzer Zeit. Steht eine Batterie unter 10,8 Volt entladen länger herum, ist sie meist völlig ruiniert!

Auch braucht es enorm viel Strom, die Batterie aus dem "Tiefentladen"-Zustand wieder herauszukriegen, ohne daß man von dem reingesteckten Strom etwas nutzen könnte. Beim Laden einer normal entladenen Batterie kann man den meisten reingesteckten Strom wieder nutzen. Es ist wie mit einem Karren, den man den Berg hinaufschiebt und wieder runterrollen läßt. Unten ist aber ein Sumpfloch. Läßt man den Karren zu tief herunterrollen, versinkt er im Morast und man muß sich unendlich mühen, ihn wieder herauszukriegen, ohne daß man nur ein Stück bergauf gekommen wäre...

Darum müssen wir regelmäßig den Ladezustand der Batterien prüfen! Wer wartet, bis das Licht dunkler wird oder gar das Radio nicht mehr spielt, hat die Batterien bald verdorben, denn selbst eine tiefentladene Batterie läßt die Glühlampe noch leuchten und am Radio merkt man noch längst nichts!

Dauernd zu hoher Ladestrom schadet ebenfalls, kurzzeitig macht's nichts. Richtwert: 1/10 der Ampèrestundenzahl, die auf der Batterie steht, nicht längere Zeit überschreiten, also reicht z.B. eine 96-Ah-Batterie für Ladestrom bis 9A. Da die Höchstleistung des Windrades (z.B. 15A) nur bei starken Böen rauskommt, ist es pffiffig, nur in dem Moment automatisch per Überladeschutzschaltung eine zweite Batterie mitzuladen, z.B. die, aus der gerade Strom verbraucht wird.

Dementsprechend schließe genügend Batterien ans Windrad, aber nicht zu viele, denn jede Batterie hat eine Selbstentladung und bei zu vielen Batterien frißt die Selbstentladung einen Großteil des Stromes auf. Außerdem schadet auch zu schwacher Ladestrom: Die Batterie muß ab und zu mal blubbern, sonst sinkt die vom Laden konzentrierte Säure nach unten, oben bleibt die zu dünne Säure stehen, in der die Platten von oben her sulfatieren. Hast Du einige Wochen kaum Wind, schwenke die Batterien gelegentlich etwas hin und her, um die Säure zu durchmischen.

Schließt Du mehrere Batterien parallel zusammen, sorgt stets die schlechteste dafür, daß sich alle anderen ebenso schnell entladen. Der Trick "Entkoppeln durch Dioden" ist auch schlecht: Sowohl beim Laden als auch beim Entladen mindestens 0,7 V Verlust ("Staudamm-Effekt"), zusammen 10-15% Verlust! Besser die Batterien mit Umschaltern einzeln anschließen, dann merkst Du auch gleich, welche es ist, wenn mal eine kaputtgeht. PKW - Batterien vom Schrott halten meist nicht länger als noch 1 Jahr, dagegen waren LKW - Batterien mit der Bezeichnung "rüttelfest" meistens noch jahrelang äußerst zuverlässig. Offenbar zerfallen deren Platten nicht so leicht.

Was beim Aufladen blubbert, ist Knallgas, hochexplosiv! Vermeide jeden Funken bei Batterien, die geladen werden. Der Batterieladeplatz muß gut belüftet sein. (s.S.75)!

Für 12 Volt muß Du dicke Kabel legen, je länger der Weg und je höher die Leistung, umso wichtiger. Denn hier sind die Ströme hoch, Widerstand dünner Kabel verursacht große Verluste!

Extra prima: Automatische Schutzschaltungen

Eine geeignete (!) Überladeschutzschaltung gibt auch ohne Beobachten die Sicherheit, daß die Batterie nicht überladen wird. Der Regler an der LiMa muß ja weg, damit das Windrad bei vollen Batterien sicher bleibt und keine Überdrehzahl kriegt. Hier meine Selbstbau - Schaltung :

Ganz einfache Bauteile!
Ruhestromverbrauch ca. 0,01W.
E = Einschaltspannung hier einstellbar, z.B. 14,4 Volt
A = Abschaltspannung hier einstellbar, z.B. 1/2 Volt weniger.

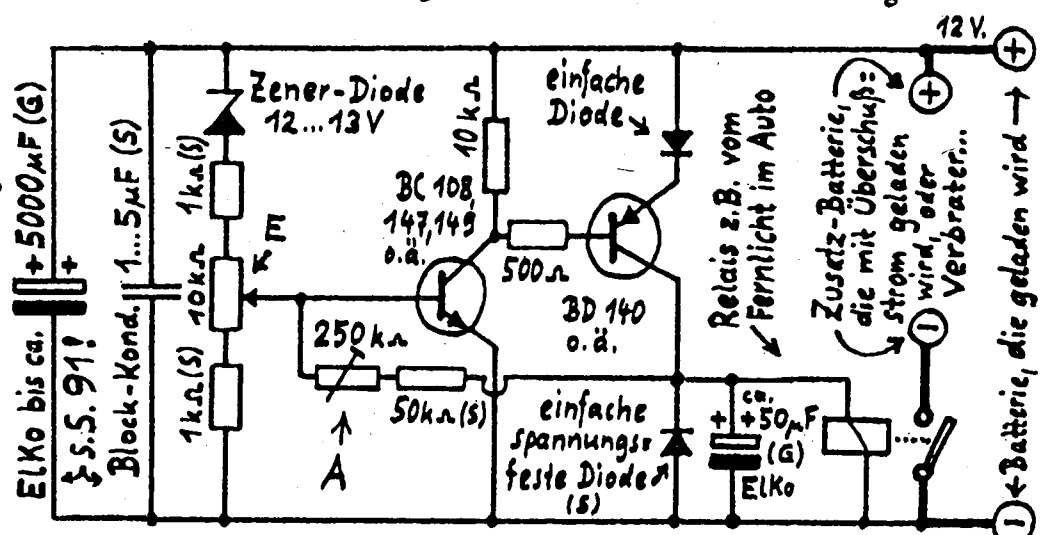

(G): Glätt-Kondensatoren, nötig wenn statt Zusatzbatterie ein (nicht zu starker) Verbraucher dran ist, sonst rattert das Relais!

Widerstandswerte dürfen etwas abweichen. (S): Schutz-Teil für Transistoren, wichtig!

Vorsicht bei handelsüblichen Laderegler- und Schutzschaltungen! Die Sorte, die die Batterie vom Stromerzeuger trennt, sobald die Batterie voll ist (üblich und harmlos bei Solarzellen) zerstört jede LiMa im Nu! Die LiMa darf nie ohne angeschlossene Batterie laufen, sonst brennt sie durch! Verwende nur Schaltungen, die parallel zur Batterie angeschlossen werden, wo also die Ladestromkabel vom Windrad zur Batterie immer direkt angeschlossen bleiben.

Dann achte auf den "Ruhestromverbrauch": Manche Schaltungen verbrauchen ständig merklich Strom, auch bei fast leerer Batterie! Willst Du, statt Überschuß - Strom zu verheizen, damit eine Reservebatterie laden, sollte die Schaltung mit einem Relais statt mit Halbleitern arbeiten: Am Halbleiter (Transistor etc.) "Staudamm - Effekt": 0,7V werden verheizt!

Gegen zu tiefes Entladen sichert diese Schaltung:

Ist die Batterie leer, schaltet das Relais die Verbraucher ab und evtl. ein Warngerät zu, z.B. aus einem alten Quarz-Wekker. Ruhestroms $\leq 1 \text{ mA}$!

ACHTUNG! So stromsparende Schaltungen reagieren auch auf "Kriechstrom" (durch Dreck und Luftfeuchte)! Zum Schutz dagegen fertige Schaltung mit Lack einpinseln!

Ruhestromverbrauch wenige Milliwatt!

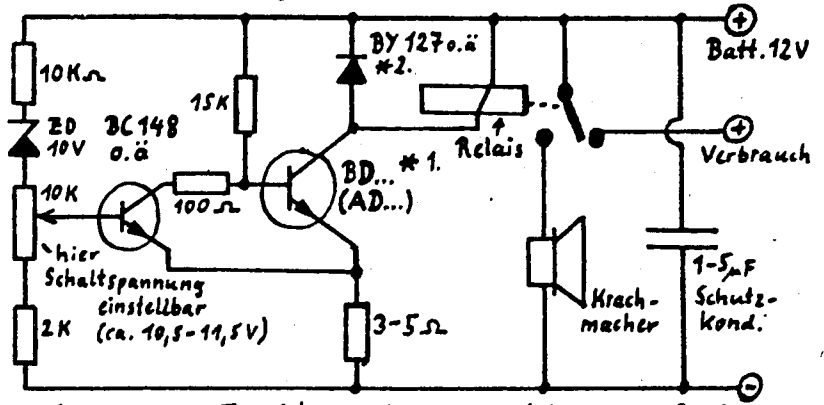

- * 1. Stärke des Transistors entsprechend Verbrauch des Relais, bei kleinen Relais reicht eine sehr starke C-Type.
- * 2. Schutzdiode gegen Spannungsspitzen vom Relais

Eine Batterie gleichzeitig zu laden und zu entladen ist ungünstig, denn Lade- und Entladestrom schwanken je nach Wind und Verbrauch so, daß die Batterie dauernd im Wechsel voller und leerer wird. Das kehrt jedesmal den chemischen Vorgang in der Batterie um, und jede Umkehrung verschleißt die Batterie.

Daher sind 2 Batterien (oder Batteriegruppen) und ein mechanischer Umschalter gut, so gebaut, daß immer eine Gruppe nur entladen und eine nur geladen wird und daß niemals keine Batterie angeschlossen ist (superwichtig, sonst brennt die LiMa ruckzuck durch!).

ca. 1/3 - 1/4 tatsächlicher Größe. Hohe Stromstärke verlangt große berührende Blechflächen!

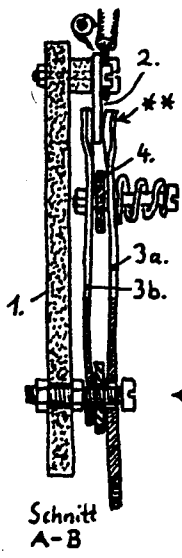
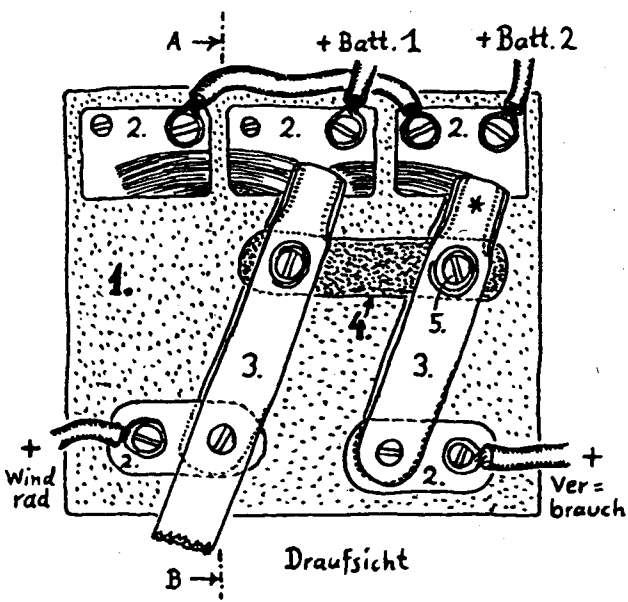

Details:

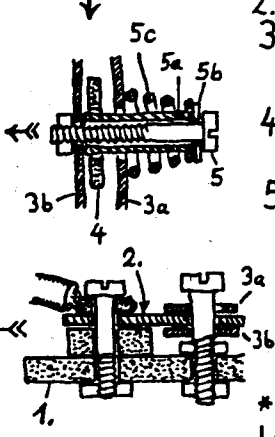

1. Grundplatte, Isoliermaterial (Pertinax od. ölgetränktes Holz)
 2. Kontaktbleche (ca. 1mm Messing)
 3. Kontaktfinger, einer verlängert als Schattheber 3a. oberer-, 3b. unterer Kf.
 4. Verbindungsstange (Isoliermaterial, z.B. Plastikseimer)
 5. Schraube mit a. Distanzröhrchen (alte Antenne) b. evtl. Unterlegscheibe c. Druckfeder, drückt die Kontaktfinger auf die Kontaktbleche.
- * Kontaktfinger breiter als die Lücke zwischen den K-blechen!
 ** Kontaktfinger-Kanten hochgebogen!

Wer große Freude am Mechanik-Basteln hat, kann den Batterie-Umschalter mit einem kleinen Scheibenwischermotor o.ä. ausstatten, der parallel zum Krachmacher an die Schaltung angeschlossen ist und so umschaltet, daß die leere Batterie nun geladen und die volle verbraucht wird. Aber Achtung: Der Strom zum Motor muß nach 1-2 Schaltvorgängen unterbrochen werden, sonst läuft der Motor, wenn beide Batterien leer sind, immer weiter und ruiniert sie!

Batterien im Schrott aussuchen, prüfen und aufbessern: (71)

Häufige Fehler sind:

1. Platten zerbröckeln, Bröckchen schließen eine Zelle kurz \Rightarrow nur noch 10 Volt.
 2. Bleioxidschlamm aus den Platten in die Zwischenräume gerieselte \Rightarrow schnelle Selbstentladung
 3. Platten sulfatiert (s.S.69) \Rightarrow nimmt kaum Ladung an, gibt kaum Strom ab, Kapazität winzig
- Fehler 1 + 2: Reparieren lohnt nicht, giftige Patscherei! Fehler 3: Oft reparierbar!

Aussuchen im Schrott:

Sorte „rüttelfest“ und, wenn Einbaudatum draufsteht, neuere Batterien bevorzugen. Reingucken:

- Plus-Platten sollen schwarzbraun, Minus-Platten dunkelgrau sein. Hellgraue Beläge: Meist Fehler 3, evtl. reparierbar. Nicht nehmen, wenn:
 - eine oder mehrere Zellen fast ohne Säure \Rightarrow meist Fehler 1
 - Platten bröckelig, Batterie aufgebläht od. viel schwarzer Belag innen am Gehäuse \Rightarrow Fehler 2.
- Stromtest: Schutzhandschuhe anziehen, dünnes Kabel nehmen, Enden über die Pole ratschen. Dicke Funken, Kabel wird sofort heiß? Meist gut, aber Fehler 1 möglich. Fast keine Funken? Kann trotzdem gut, jedoch tiefentladen sein oder Fehler 3 haben.

Genauer prüfen:

1. Säuredichte: In den Zellen sehr unterschiedlich? Egalisieren nötig oder Fehler 1. Etwa gleichmäßig, Werte s.S.68? Gut. Gleichmäßig und deutlich unter 1,18? Tiefentladen oder Fehler 2.
2. Spannung: Gute Werte s.S.68. Unter 10,5 V, obwohl Stromtest s.o. gut? Wahrscheinlich Fehler 1. Unter 10,5 V und wenig Strom? Tiefentladen oder Fehler 2 oder 3.
3. Laden. Spannung steigt kaum über 12 V: Fehler 1 \Rightarrow Schrott. Spannung steigt schnell auf 14,4 V, obwohl Batterie leer war: Fehler 3 \Rightarrow Reparaturversuch.
4. Selbstentladung: Volladen, Stehenlassen. Nach 3-5 Tagen nur noch 11 V: Fehler 2 \Rightarrow Schrott. Nach 3 Wochen: 13 V = prima, 12 V = gut. Unter 11 V = Fehler 2 \Rightarrow schrottreif.
5. Kapazität: An vollgeladener Batterie Glühbirne brennen lassen. Strom messen (z.B. 3 A). Stunden zählen, bis Spannung auf 10,8 V gesunken. Strom x Stunden = Ampèrestundenzahl, z.B. 3 A x 10 Std. = 30 Ah. Wenn deutlich unter $\frac{1}{2}$ der Zahl, die draufsteht: Fehler 3.

Schnelltest: Kurz überladen mit Ladestrom von 15-20 % der Nennkapazität, d.h. bei 100-Ah-Batterie 15-20 A, bis auf 16-16,5 V. Nach einigen Tagen nur noch ca. 10 V? Fehler 1 oder 2 \Rightarrow Schrott. Noch ca. 12 V? Wohl brauchbar. Noch ca. 13 V? Gut.

Schlechte Batterien zurück auf den Schrott bzw. zur Schadstoffsammelstelle und tauschen. Dort sind so viele, sicher findet man bald eine brauchbare oder aufbesserungsfähige Batterie.

Aufbesserungen:

- Vergammelte Anschlüsse? Reinigen, fetten (Vaseline). Übergangswiderstände fressen Strom!
- Dreckbelag auf der Batterie? Vor allem Umgebung der Anschlüsse gut säubern und fetten, sonst Selbstentladung durch „Kriechstrom“ im Dreck, besonders bei Feuchtigkeit.
- Egalisieren: Schwache Zellen einzeln mit 2,4 V laden. Anschluß: VA-Draht auf Platten pieken.
- Fehler 3? Trick von Harm Heins, Wasmerstr.19a, 21079 HH, bewährt bei Autobatterien mit flüssiger Säure. „Wartungsfrei“-Batterie ohne Deckel? Reklameschild abpulen, Deckel sind darunter, öffnen. Versiegelte Batterie oder Gel-Batterie? Geht nicht, würde explodieren!

Sehr hohe Spannung anlegen (Batteriekette 24 V, notfalls bis zu 96 V), bis ein Ladestrom zu fließen beginnt. Sobald er (für 50 - 100 Ah-Batterie) ca. 10 A erreicht, Spannung z.B. um 12 V (=1 Batt.) verringern, weiterladen bis wieder 10 A fließt, verringern, usw. Oft ist die Batterie nach dieser Roßkur wieder normal aufladbar. Evtl. Wasser nachfüllen. Praktisch: Für jede Batterie eine

16 A – Sicherung, im Schuppen ein 10 A – Sicherungsautomat als Abschalter bei 10 Ampère. (S. 72)!

Bei 24 V Ladespannung auf 12-V – Batterie Ladestrom mit Widerständen (Kabelreste o.ä.) so regeln, daß anfangs ca. 40 – 50 % der Nennkapazität Strom fließt, Sicherung z.B. 63 A. Sinkt bald von selbst. Mit Ladestrom 15-20% der Nennkapazität weiterladen bis auf ca. 16 V. Geht am 230 V-Netz auch mit Regeltrafo oder E-Schweiß-Gerät (niedrigste Stufe) + Gleichrichter + Widerstand.

Vorgang ständig überwachen!

"NUR IM FREIEN VERANSTALTEN"

ALLE BATTERIE-DECKEL ÖFFNEN

KNALLGAS

muß entweichen!

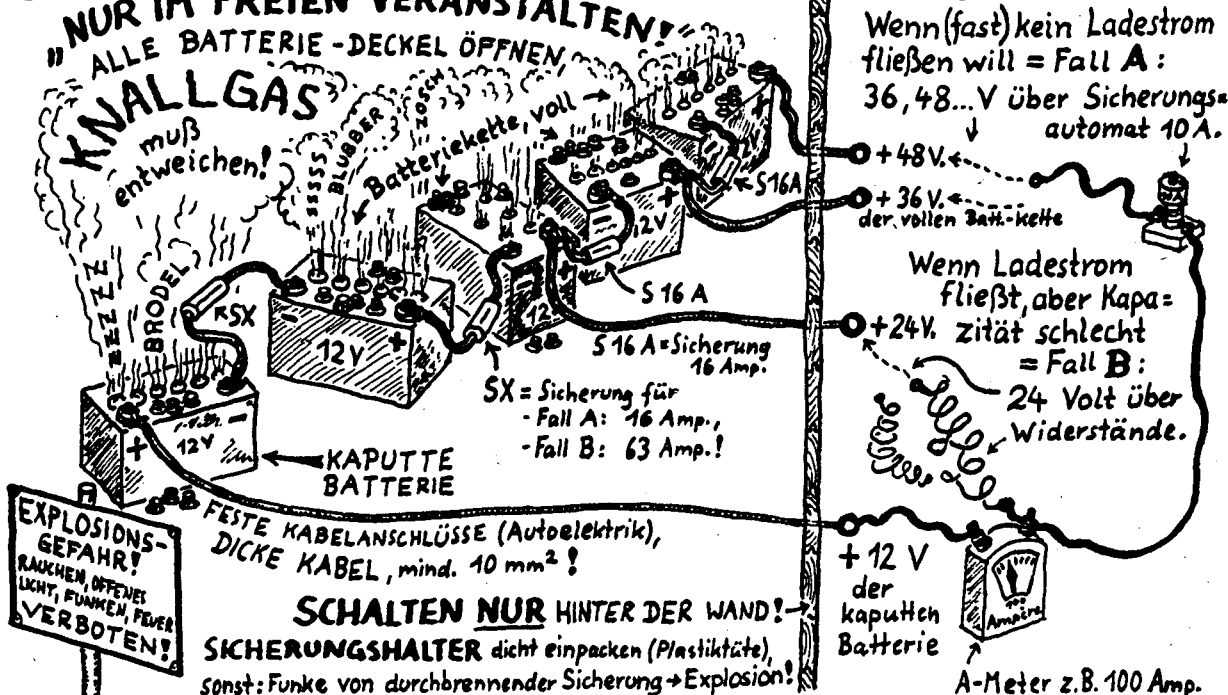

Wenn (fast) kein Ladestrom fließen will = Fall A: 36, 48...V über Sicherungsautomat 10A.

Wenn Ladestrom fließt, aber Kapazität schlecht = Fall B: 24 Volt über Widerstände.

SX = Sicherung für - Fall A: 16 Amp., - Fall B: 63 Amp.!

EXPLOSIONS-GEFAHR!
RAUCHEN, OFFENES LICHT, FUNKEN, FEUER VERBOTEN!

FESTE KABELANSCHLÜSSE (Autoelektrik), DICKE KABEL, mind. 10 mm²!

SCHALTEN NUR HINTER DER WAND!

SICHERUNGSHALTER dicht einpacken (Plastiktüte), sonst: Funke von durchbrennender Sicherung -> Explosion!

Sicherheit: Gegen Kabelbrand jede Batterie einzeln absichern! Feste Kabelanschlüsse an den Batterien! Viel Knallgas entsteht, Batterien müssen draußen stehen! Kabel in einen Schuppen o.ä. führen, nur dort darf geschaltet werden, niemals an den Batterien, sonst Explosion durch Funken!

Hinweis: Nickel-Cadmium-Akkus (sehr dauerhaft) und Nickel-Eisen-Akkus (weniger giftig) gibt's gebraucht von der Post oder der Bundeswehr (würg), steht im Bundesausschreibungsblatt. Mehr zu Auto-, Solar-, Gel- und Spezial-Batterien im Einfälle-Heft „Solarstrom in 12-Volt-Anlagen“.

Wie vielseitig man den Windstrom nutzen kann...

Wir haben 12V Gleichstrom und durchschnittlich 200 Wh Leistung am Tag, in windschwachen Gebieten weniger, in windstarken mehr. Damit können wir z.B. Licht machen: Eine 21W-Autoglühbirne gibt fast so viel Licht wie eine 40 W-220 V-Birne, denn Niederspannungsbirnen haben eine höhere Glühfadentemperatur. 20-W-Halogenbirnen sind noch viel heller, oft reicht schon eine 10-W-Birne am richtigen Platz. Noch sparsamer sind Leuchtstofflampen mit angebaute Wandler (Campingbedarf), aber leider nicht frei von "Elektrosmog".

Wir können hier täglich vier 21-W-Birnen 2 1/4 Stunden lang brennen lassen oder eine 9 Stunden lang oder stundenlang Radio oder Tonband hören, wenn es Transistorgeräte sind, die sich mit 12 V betreiben lassen.

In Batteriegeräte wie Radio oder Recorder ohne 12V - Anschluß stecke Besenstiele mit Kabeln dran ins Batteriefach, führe die Kabel raus und schließe sie an den Windstrom an, von dem Du vorher in Dioden soviel verbrätst, daß gut die Spannungen der Batterien, die früher im Radio waren, rauskommen. Beispiel: drin waren $6 \times 1,5V = 9V$. 12V Windstrom erst durch 4 Dioden in Reihe (je 0,7V Staudammeffekt = 2,8V) schicken, bleiben 9,2V übrig; paßt prima! Und die Dioden schützen vor falsch gepoltem Anschließen.

Aber dies alles sind kleine Stromverbraucher. Einen elektrischen Heizlüfter könnte man 6 min betreiben, einen elektrischen Durchlauferhitzer ca. 45 sec täglich. Maschinen aller Art können wir mit 12V-Elektromotoren aus Schrottautos (Scheibenwischer) antreiben. Starke 12V-Motoren sind Gleichstromlichtmaschinen, wenn sie ohne Regler als Nebenschlußmotoren geschaltet sind. Mit der Stromausbeute von 2 Tagen Windstrom kann man eine Waschmaschine laufen lassen, die mit einem solchen Motor ausgerüstet wurde. Allerdings muß das Wasser dazu extra warm gemacht werden, am besten im Sonnenkollektor, notfalls auch im Badeofen oder in der Gastherme.

Der 12V-Gleichstrom ist auch recht ungefährlich, zum Elektronikbasteln bestens geeignet, und die stromdurchflossenen Kabel sind nicht von Wechsel-Magnetfeldern umgeben wie bei üblichen Stromnetzen (Elektrosmog). Mehr dazu im Einfälle-Heft „Solarstrom in 12-Volt-Anlagen“.

In Batteriegeräte wie Radio oder Recorder ohne 12V - Anschluß stecke Besenstiele mit Kabeln dran ins Batteriefach, führe die Kabel raus und schließe sie an den Windstrom an, von dem Du vorher in Dioden soviel verbrätst, daß gut die Spannungen der Batterien, die früher im Radio waren, rauskommen. Beispiel: drin waren $6 \times 1,5V = 9V$. 12V Windstrom erst durch 4 Dioden in Reihe (je $0,7V$ Staudammeffekt = $2,8V$) schicken, bleiben $9,2V$ übrig; paßt prima! Und die Dioden schützen vor falsch gepoltem Anschließen.

Inzwischen gibt es alle nur erdenklichen Haushaltsgeräte auch in 12 - Volt - Ausführungen im Campingbedarf, weil man heute statt mit Rucksack und Zelt mit rollenden Haushalten unterwegs sein muß (!?!). Natürlich ist auch viel unnützer Schnickschnack dabei, oder furchtbar gierige Stromfresser, wie Kühlschränke mit 12V - Heizspiralen. Motorgeräte können wir oft umbauen, indem wir Autoelektrik einbauen. Sogar windstrombetriebene Waschmaschinen sind so möglich, wenn das Wasser statt elektrisch mit Sonnenkollektoren, Feuer oder Gas geheizt wird.

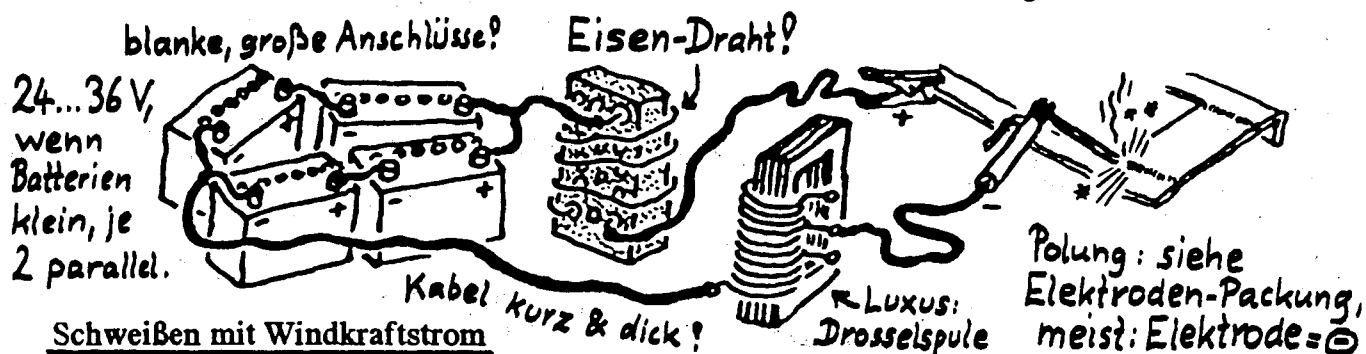

Schweißen mit Windkraftstrom ist keine Zauberei, die Batterien sammeln mit der Zeit die "kleinen Mengen" Strom vom Windrad, können ihn aber "auf einen Schlag" abgeben: der höchste zulässige Strom, der auf einmal entnommen werden darf, steht auf der Batterie, z.B. 12V 110Ah 450A. Doch darunter leidet die Batterie, lieber nur bis $1/4$ dieses Stromes belasten, bei kleinen Batterien besser zwei parallel schalten. Wir brauchen 24 - 36 Volt. Ich habe auch schon mit 3 superschrottigen PKW-Batterien prima geschweißt.

Wichtig: dicke Kabel (wie "Starthilfe - Kabel" von Nachbar's Autozubehör), gute, großflächige Anschlüsse und der "automatische Schweißstromregler": nicht zu dicker Eisendraht (Zaundraht um Ziegelstein wickeln), Eisendraht läßt kalt (geringe Last) Strom leicht durch, wird er heiß (Überlast), steigt sein Widerstand rapide und begrenzt den Strom. Für Elektroden 2 - 2,5 mm Ø, ca. 3 - 5 m Draht 2 mm Ø, wahlweise einen oder zwei parallel. Günstig sind Abgriffe zum Stromstärke - wählen.

Das Schweißen geht sauberer als mit üblichen Atomstrom - Schweißtrafos! Superedel ist noch eine zusätzliche Drosselspule (aus dickem Schrott - Trafo). Aus Baukalk soll man Elektrodenumhüllungen selbst machen können. Wenn das gelingt, wären wir völlig "kommerz - unabhängig"!

Für 12 Volt muß Du dicke Kabel legen, je länger der Weg und je höher die Leistung, umso wichtiger. Denn hier sind die Ströme hoch und der Widerstand dünner Kabel verursacht große Verluste!

1 mm² Kupferkabel hat ca. 18 Ω Widerstand pro km.

Für Dauerbetrieb: ca. 5% Verlust möglichst nicht überschreiten!

Faustformel:

$$\% \text{ Verlust bei } 12 \text{ Volt} = \frac{\text{Länge (m)} \cdot \text{Strom (Amp.)}}{\text{Querschnitt (mm}^2\text{)} \cdot 6}$$

Für 5% Verlust erlaubte Kabellänge (Hin- und Rückweg beachten):

für Strom bei	1mm ²	2,5"-11-	6"-11-	Querschn.
2 Amp.	16	40	100	} ca. Meter
5 "	6	16	40	
10 "	3	8	20	

Manches handliche 220V - Gerät ist schwer umzubauen oder die Mühe lohnt nicht, weil wir es nur selten benutzen (z.B. Elektrowerkzeuge). Hier kann ein Umformer von 12 auf 220V sinnvoll sein, während er für den alltäglichen Bedarf viel zu viel Verluste macht. Grundregel: Was irgend geht, direkt als 12V - Strom verbrauchen.

Laden wir eine Batteriekette von 110 oder 220V, können wir den Hochspannungs - Gleichstrom in allen 110 - bzw. 220V - Geräten direkt verbrauchen, die auch für Gleichstrom geeignet sind: Glühbirnen, Motorgeräte mit Allstrommotoren (hat Kohlebürsten), wie Bohrmaschine, Staubsauger usw. ohne elektronische Regler! Heizgeräte ohne Wechselstrom - E - Motor, also Fön älterer Bauart, Heizsonne, Bügeleisen oder Warmwasserboiler gingen auch, aber wie gesagt, schade um den Strom! Typenschild beachten: manchmal steht "220V~" drauf, obwohl sie auch für Gleichstrom gehen. Im Zweifelsfall Elektriker fragen!

An 220V - Gleichstrom gehen nicht (oder sogar kaputt!): Alles mit Trafo's, Umformern und Wechselstrommotoren (die leise laufenden ohne Kohlebürsten): Energiesparlampen, Neonröhren, Kühlschränke, Heizlüfter usw.

Das 220V - Gleichstromnetz ist ebenfalls frei vom Elektrosmog der üblichen Stromnetze. Vorteilhaft ist auch, daß wir in einem Haus die vorhandenen Kabel ohne nennenswerte Stromverluste weiterverwenden können.

Wollen wir 12V aus der Batterie - Kette holen, darf immer nur so viel aus jeder Batterie verbraucht werden, daß alle immer etwa gleichmäßig geladen bleiben, sonst blubbern alle Batterien vor Überladung, während eine leer ist. Entweder Dioden zum Verbrauchsstrom, oder motorbetriebener Umschalter, der, wenn die Batterie z.B. 0,5 Volt leerer ist, auf die nächste umschaltet. Strom für den Motor über die Tiefentladeschaltung (anders eingestellt).

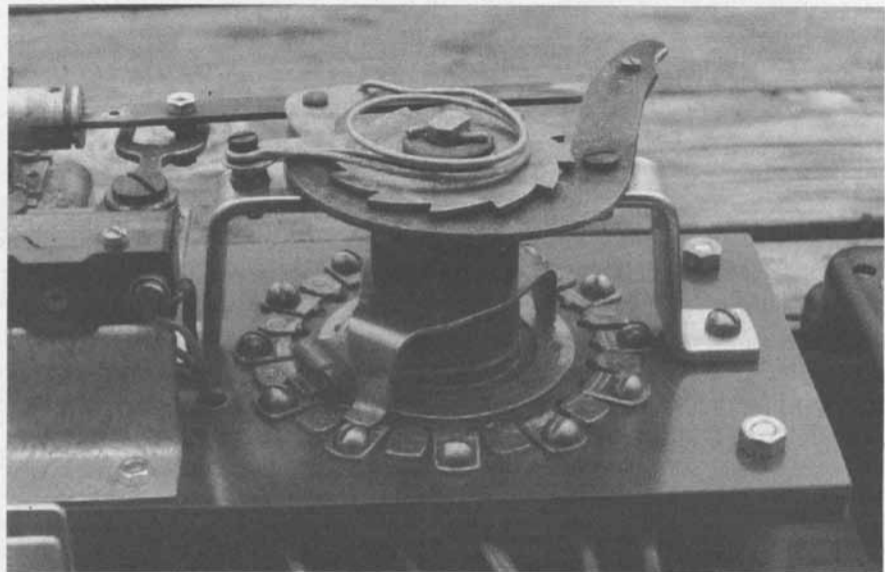

Selbstgebauter motorbetriebener Umschalter für 12 V aus 120-V-Kette.